

CP6742-0000-0040

main dimensions and
fixing points

dimensions in mm

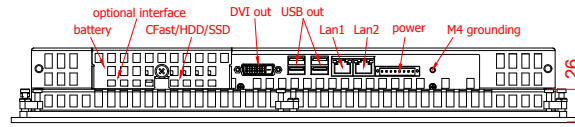

bottom view

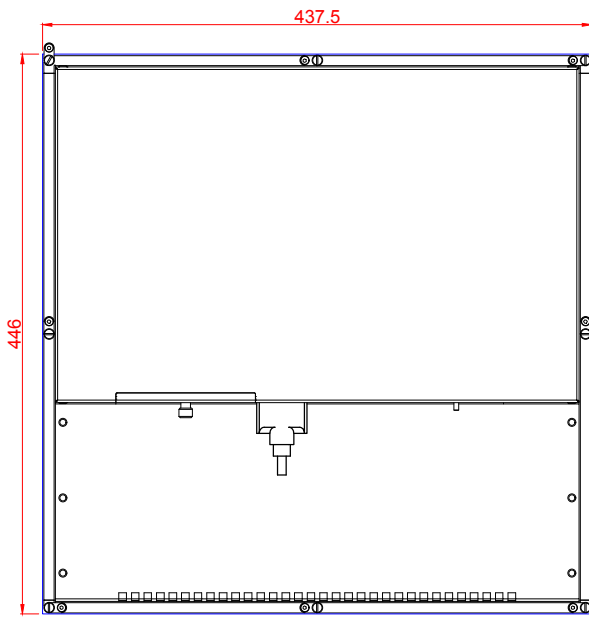

cut out dimensions: 446mm x 437,5mm

rear view

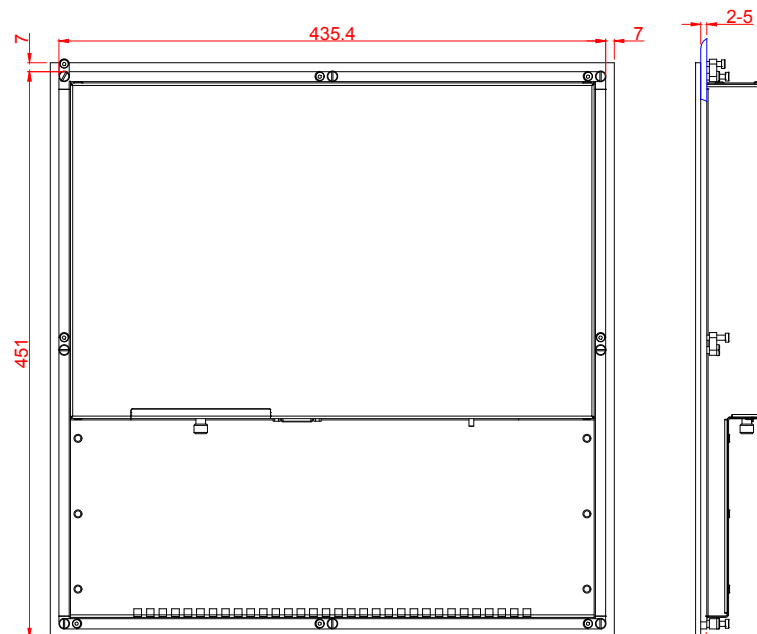

rear view

left view

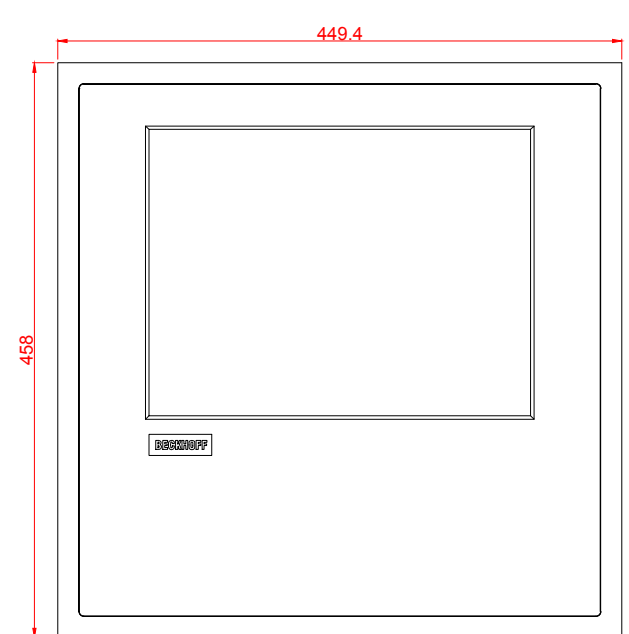

front view