

CP3219-E279-M406

main dimensions and
fixing points

dimensions in mm

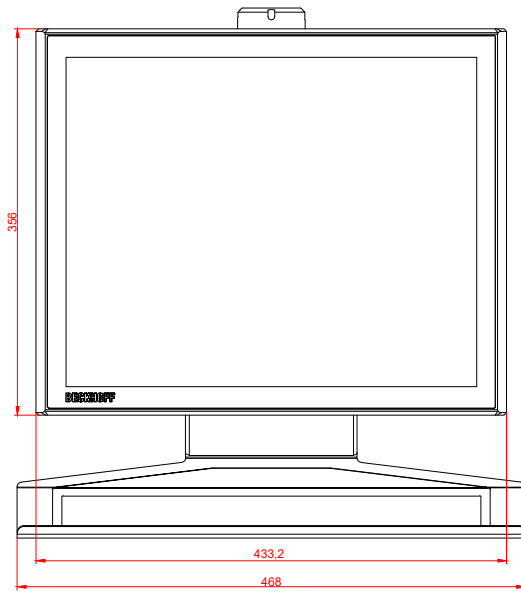

front view

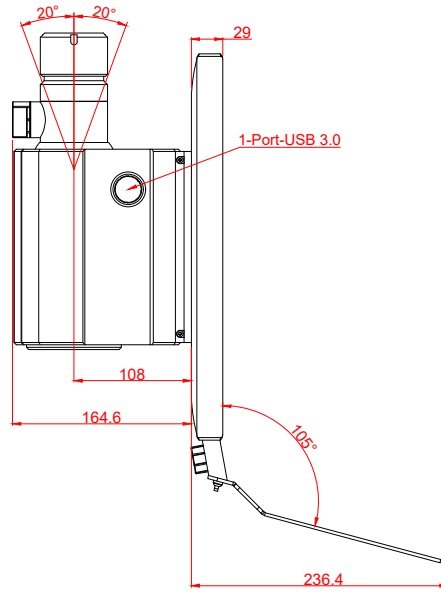

side view

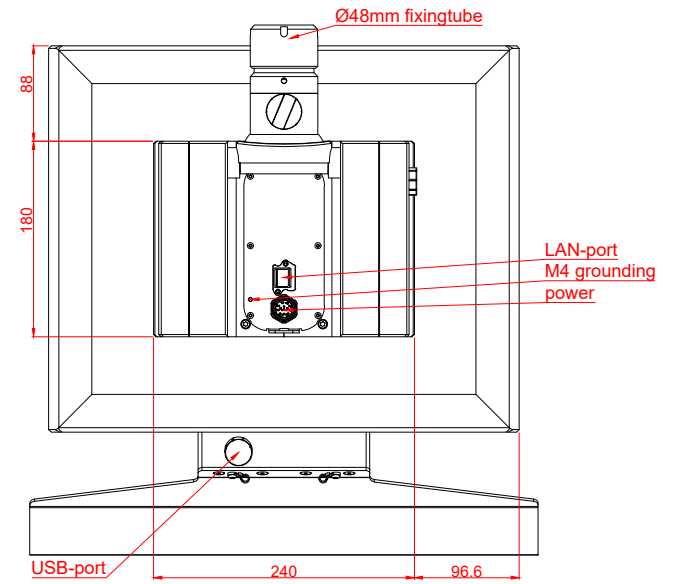

rear view

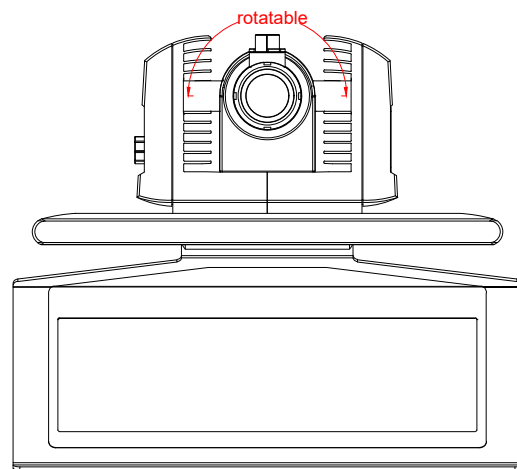

top view

