

CP3216-M184-E281-M406

main dimensions and  
fixing points

dimensions in mm

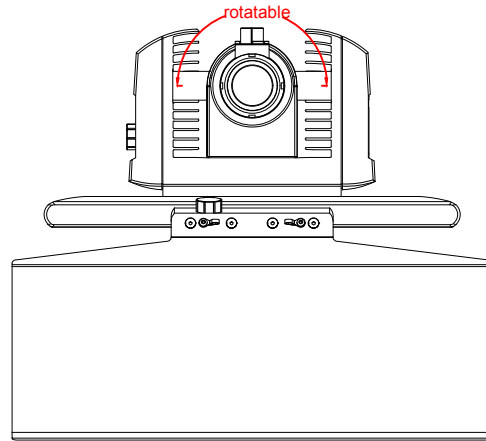

bottom view

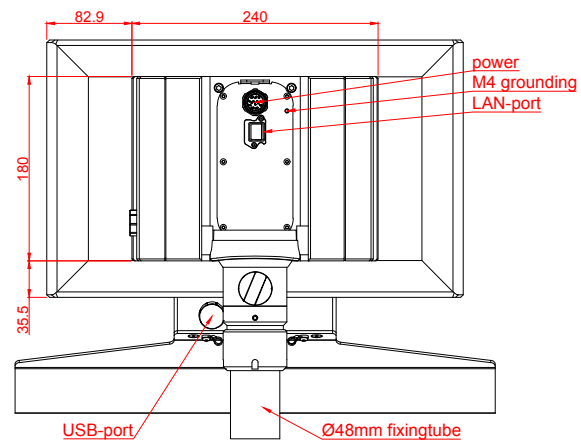
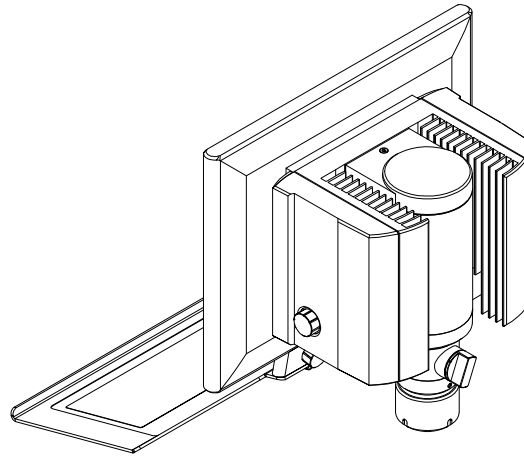

rear view

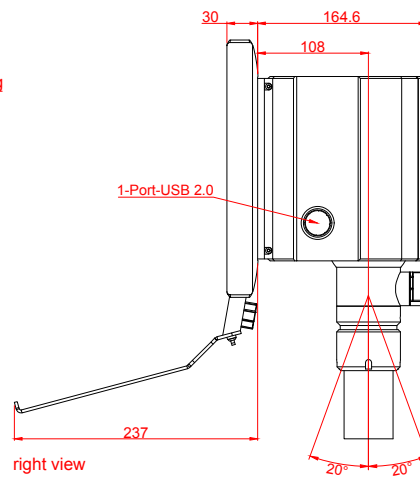

right view

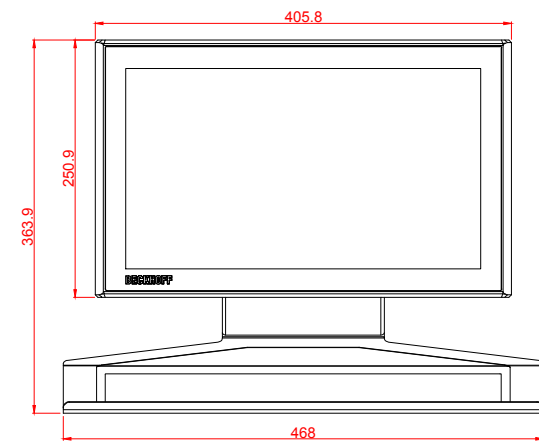

front view