

CP3216-E281-M406

main dimensions and  
fixing points

dimensions in mm

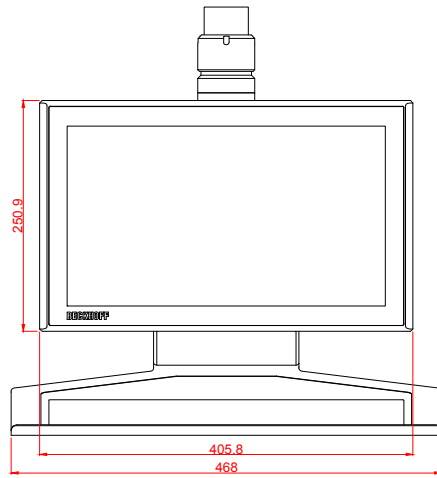

front view

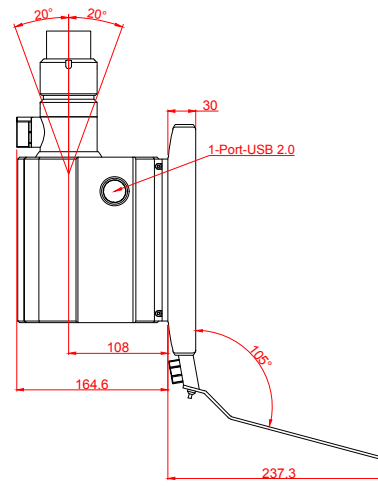

left view

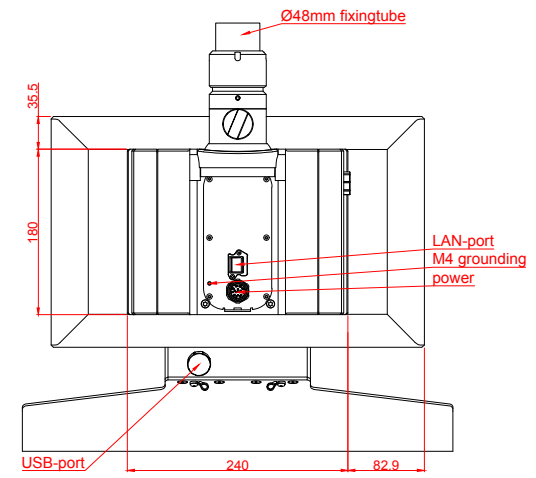

rear view

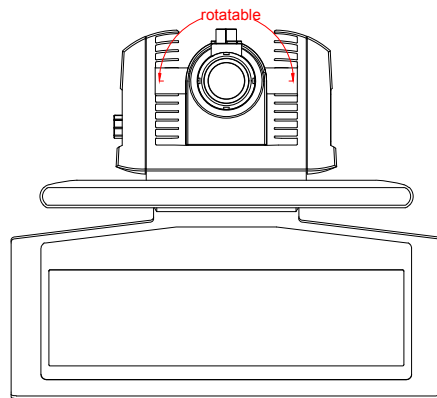

top view

