

bottom view

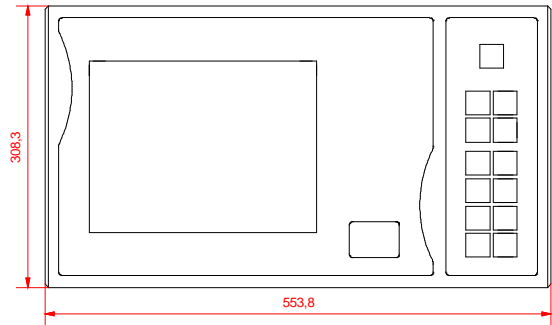

front view

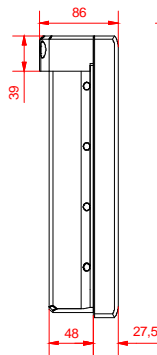

left view

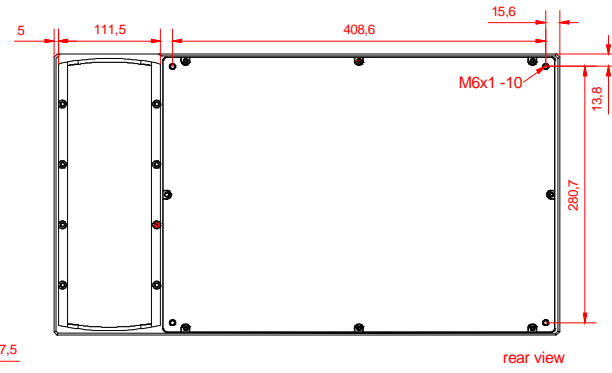

rear view

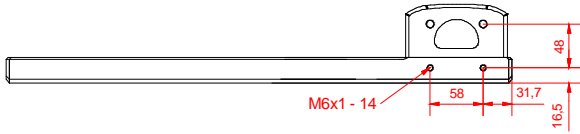
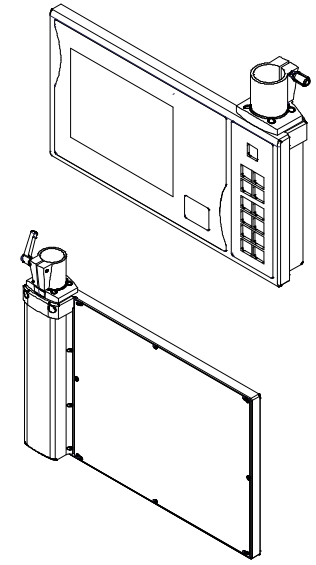

top view

CP7021 - 0002- E608
arm adapter for
Rolec - Tara - suspension adaption
146.025.019

main dimensions and
fixing points

dimensions in mm



bottom view

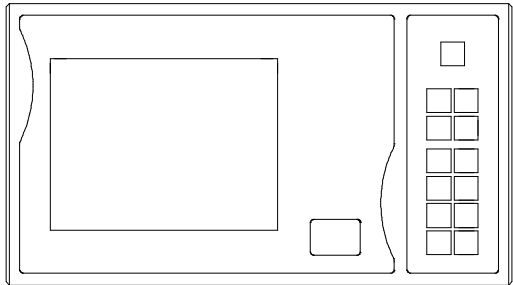

front view

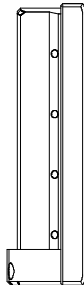

left view

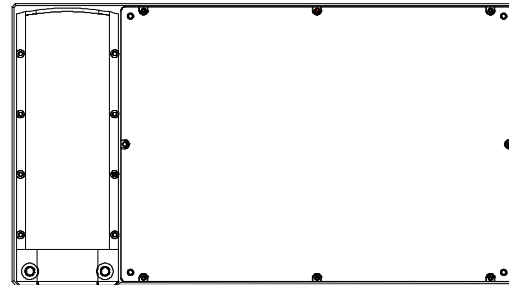

rear view

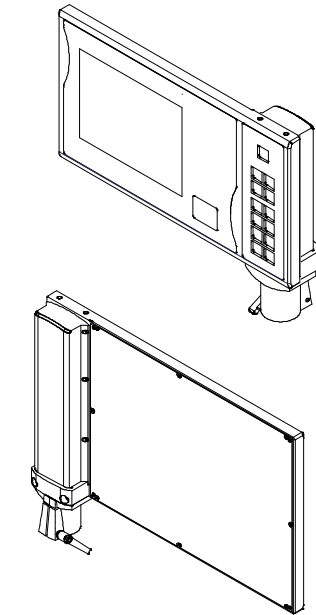

top view