

CP3919-0000  
with  
C9900-M575  
C9900-M750  
C9900-E274  
C9900-M406

main dimensions and  
fixing points

dimensions in mm

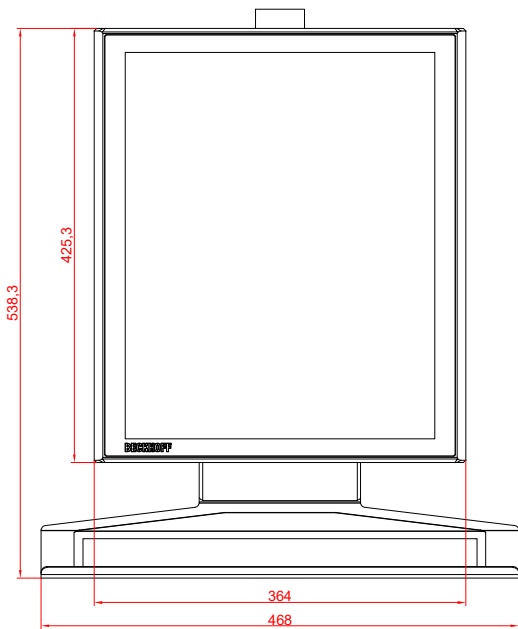
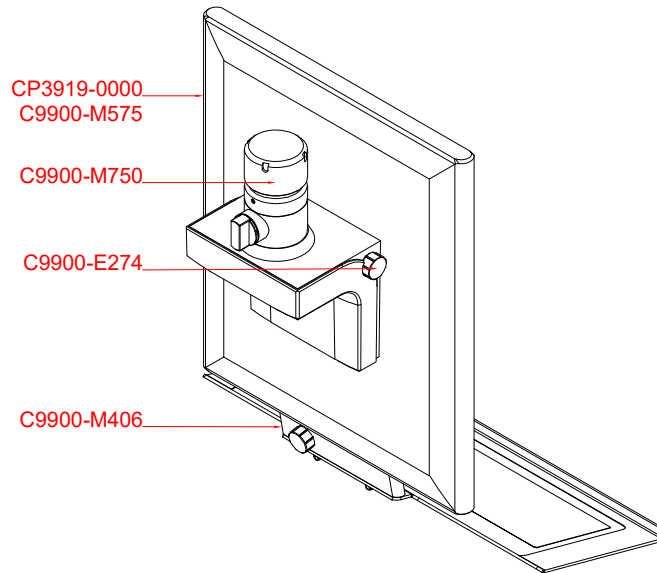

front view

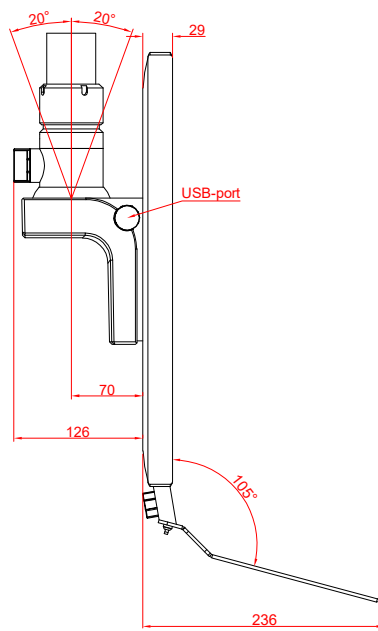

side view

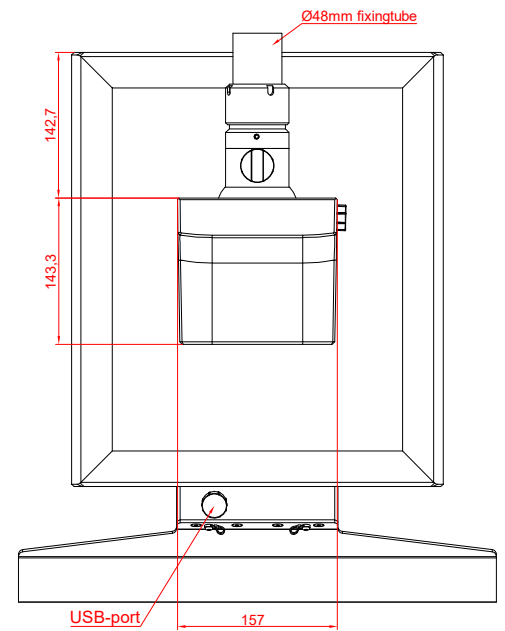

rear view

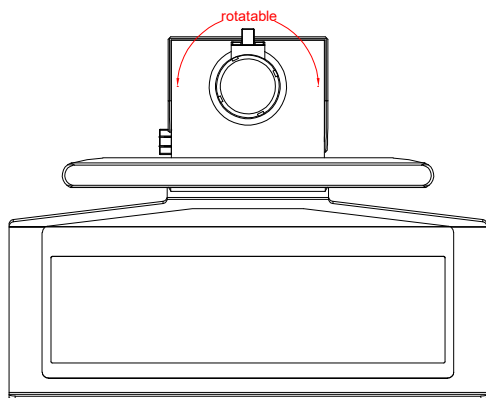

top view

