

CP3919-0000
with
C9900-G026
C9900-M752
C9900-M406

main dimensions and
fixing points

dimensions in mm

CP3919-0000
C9900-G026

C9900-M752

C9900-M406

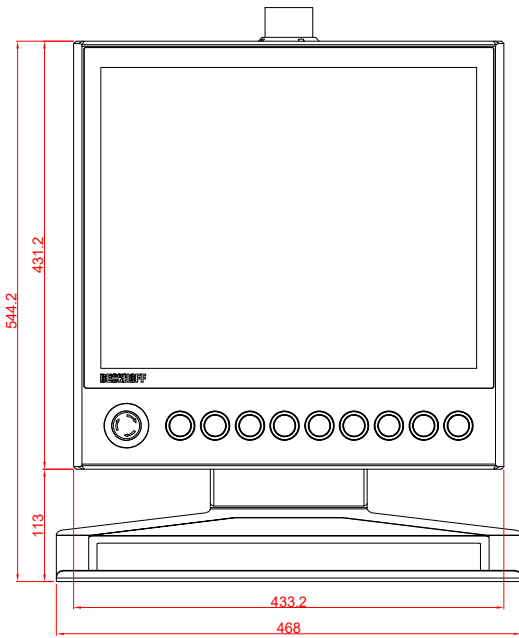
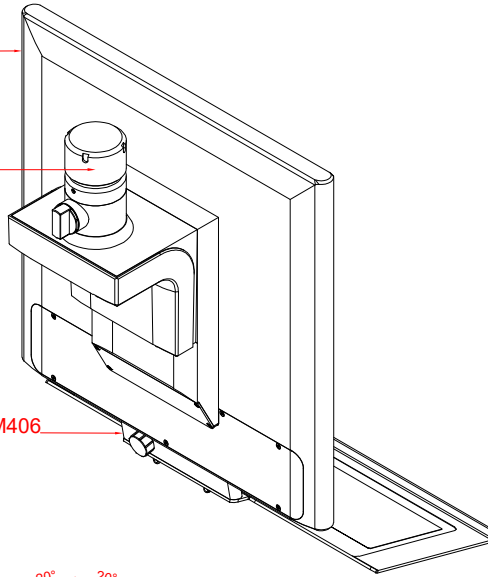

front view

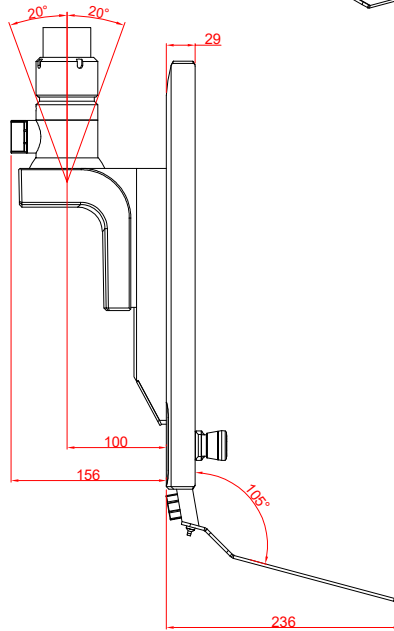

side view

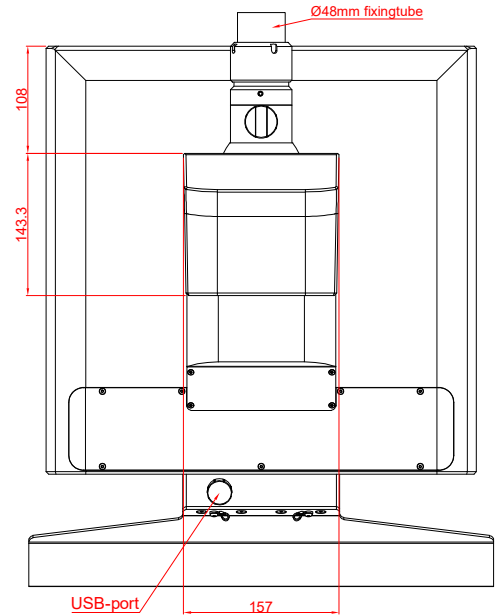

rear view

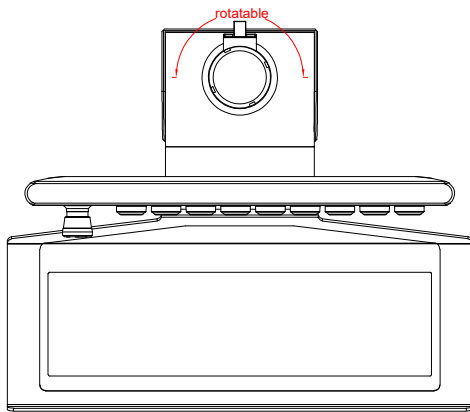

top view

