

CP3918-0000
with
C9900-G025
C9900-E274
C9900-M406

main dimensions and
fixing points

dimensions in mm

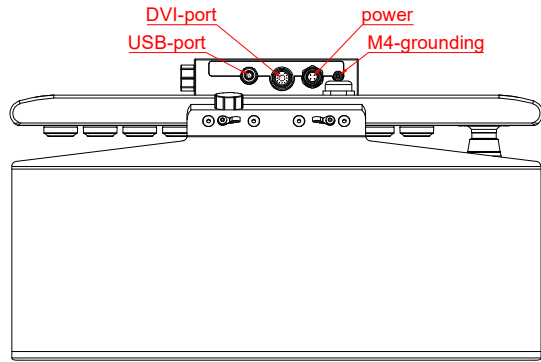

bottom view

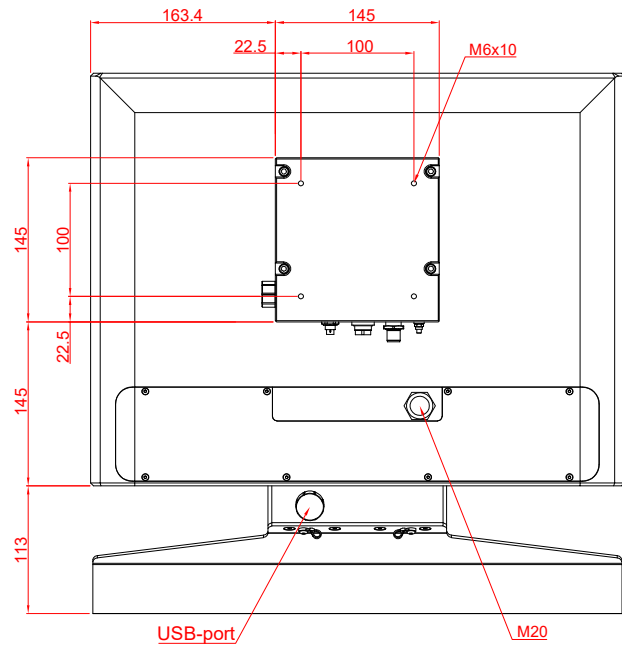
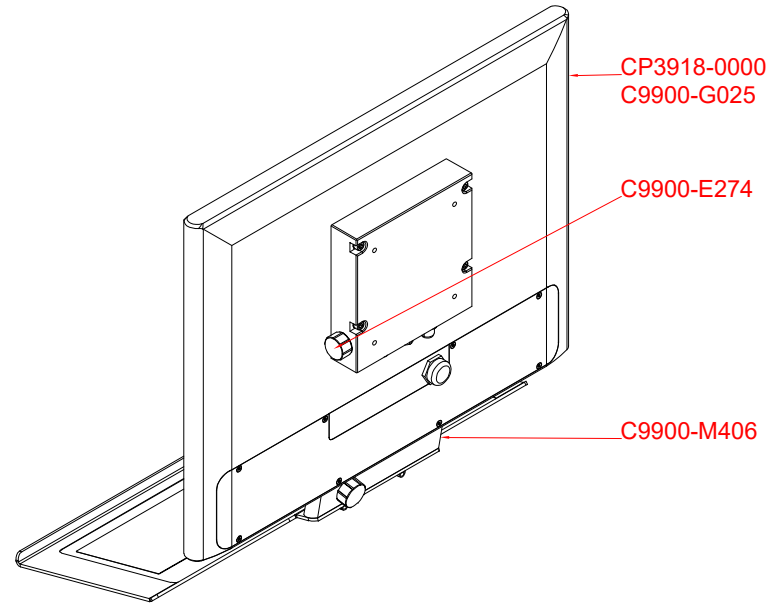

rear view

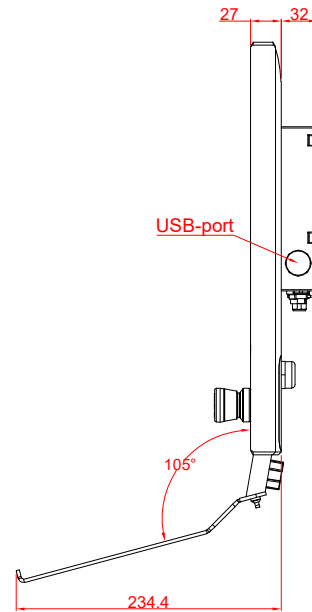

side view

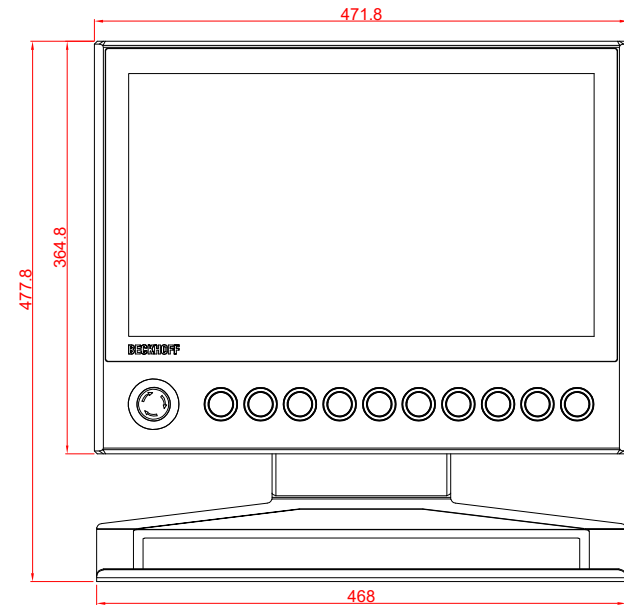

front view