

CP3915-0000
with
C9900-M575
C9900-M750
C9900-M406

main dimensions and
fixing points

dimensions in mm

CP3915-0000
C9900-M575

C9900-M750

C9900-M406

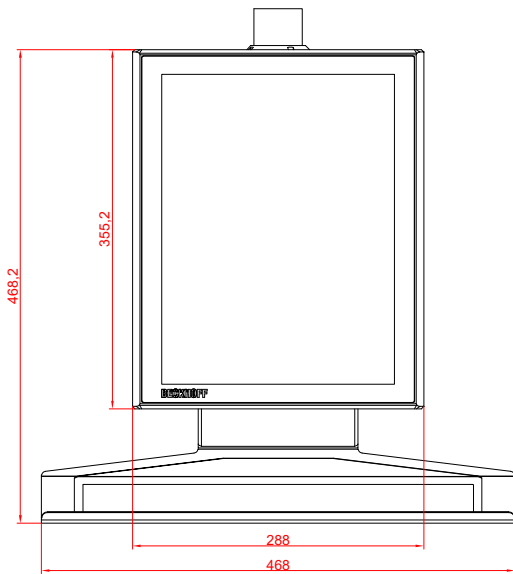
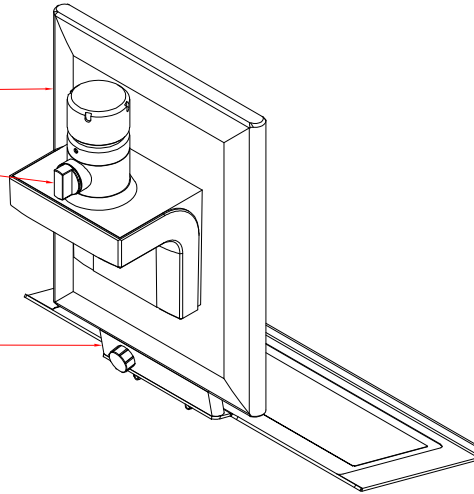

front view

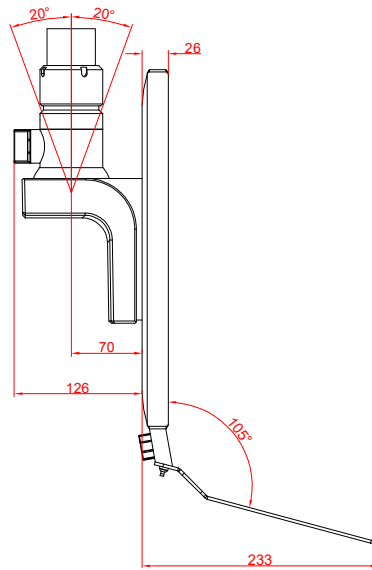

side view

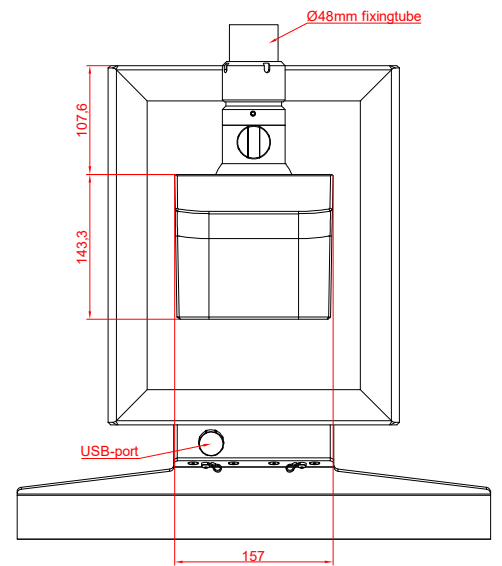

rear view

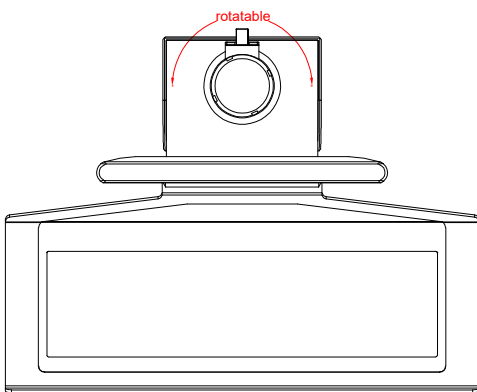

top view

