

front view

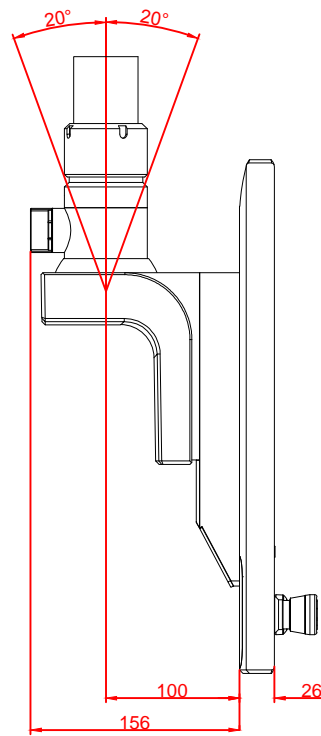

left view

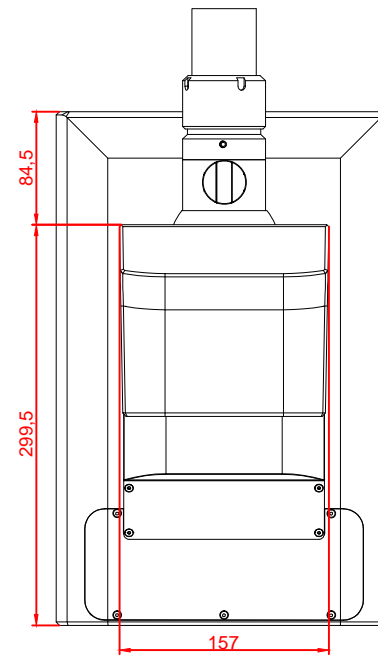

rear view

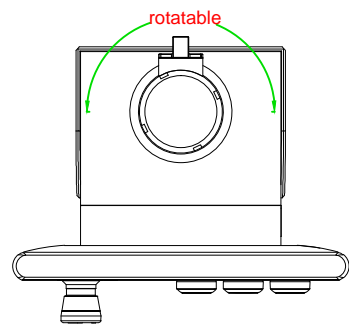

top view

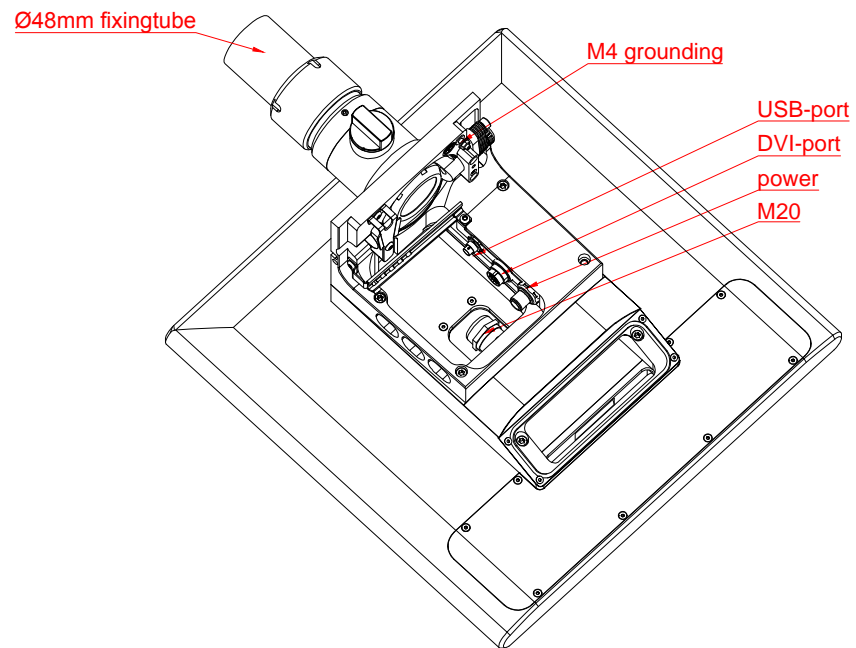

CP3912-M575-G032-M752

main dimensions and
fixing points

dimensions in mm