

CP3912-0000
with
C9900-M575

main dimensions and
fixing points

dimensions in mm

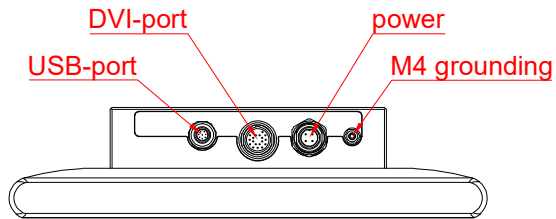

bottom view

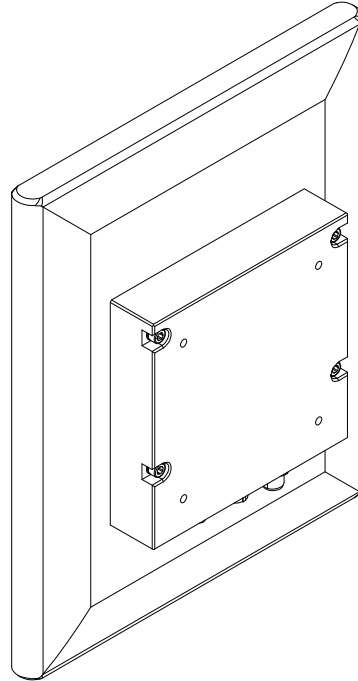

CP3912-0000
C9900-M575

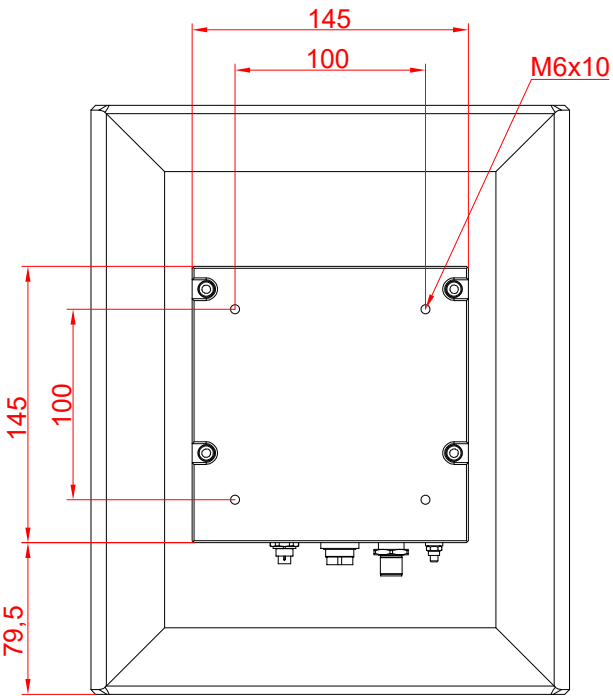

rear view

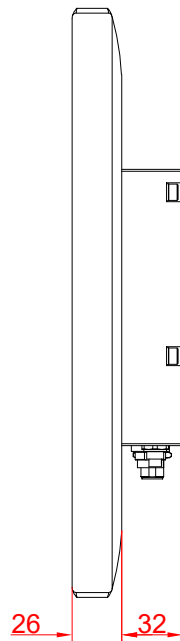

side view

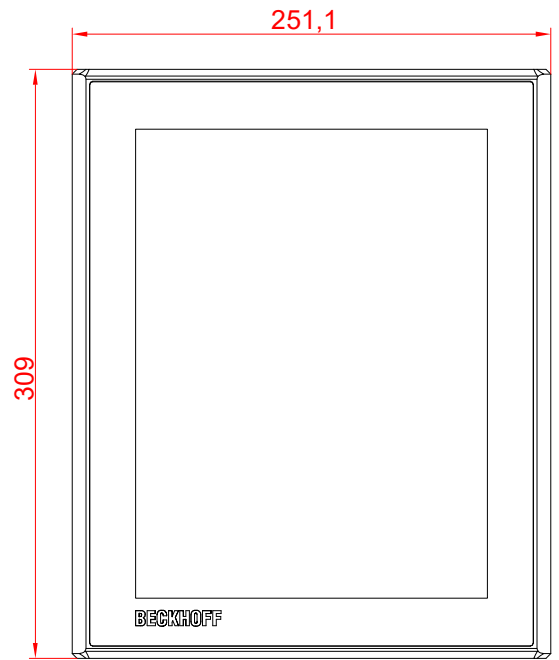

front view