

Operating instructions | EN

AL8200

Magnetic Encoder system (MES) for Linear motors AL8000



Table of contents

1 Documentation notes	5
1.1 Disclaimer	5
1.1.1 Trademarks	5
1.1.2 Patents	5
1.1.3 Limitation of liability	6
1.1.4 Copyright	6
1.2 Version numbers	7
1.3 Scope of the documentation	7
1.4 Staff qualification	8
1.5 Safety and instruction	10
1.6 Explanation of symbols	10
1.6.1 Pictograms	10
1.7 Beckhoff Services	12
1.7.1 Support services	12
1.7.2 Training offerings	12
1.7.3 Service offerings	12
1.7.4 Headquarters Germany	12
1.7.5 Downloadfinder	13
2 For your safety	14
2.1 General safety instructions	14
2.1.1 Before operation	14
2.1.2 During operation	15
2.1.3 After operation	16
3 Product overview	17
3.1 Name plate	18
3.2 Type key	18
3.3 Ordering options	19
3.3.1 Connection cable	19
3.4 Product characteristics	20
3.5 Intended use	21
3.5.1 Improper use	21
4 Technical data	22
4.1 Definitions	22
4.1.1 Technical terms	22
4.2 Properties	22
4.3 Dimensional drawings	23
5 Scope of supply	24
5.1 Packaging	24
6 Transport and storage	25
6.1 Conditions	25
6.2 Transport	25
6.3 Long-term storage	25
7 Mechanical installation	27

7.1	Requirements	27
7.2	Assembly	27
7.3	Verification	28
8	Electrical installation	29
8.1	Connection technology	29
8.1.1	Cables	29
8.2	Connector assignment	30
8.2.1	AL8200-0000-0000	30
8.2.2	AL8200-0001-0000	30
9	Commutation and commissioning	31
9.1	Commutation	31
9.2	Commissioning	32
10	Maintenance and cleaning	37
10.1	Cleaning agents	37
10.1.1	Not applicable	37
11	Accessories	38
11.1	ZK4510-0020-xxxx	38
12	Decommissioning	39
12.1	Disassembly	39
12.2	Disposal	40
12.2.1	Returning to the vendor	40
13	Guidelines and Standards	41
13.1	Standards	41
13.2	Guidelines	41
13.3	Test centers	41
13.4	EU conformity	42
13.5	CCC conformity	42
14	Notes	43

1 Documentation notes

1.1 Disclaimer

Beckhoff products are subject to continuous further development. We reserve the right to revise the documentation at any time and without notice. No claims for the modification of products that have already been supplied may be made on the basis of the data, diagrams, and descriptions in this documentation.

1.1.1 Trademarks

Beckhoff®, TwinCAT®, TwinCAT/BSD®, TC/BSD®, EtherCAT®, EtherCAT G®, EtherCAT G10®, EtherCAT P®, Safety over EtherCAT®, TwinSAFE®, XFC®, XTS® and XPlanar® are registered and licensed trademarks of Beckhoff Automation GmbH.

The use by third parties of other brand names or trademarks contained in this documentation may lead to an infringement of the rights of the respective trademark owner.

1.1.2 Patents

The EtherCAT technology is protected by patent rights through the following registrations and patents with corresponding applications and registrations in various other countries:

- EP1590927
- EP1789857
- EP1456722
- EP2137893
- DE102015105702



EtherCAT® is a registered trademark and patented technology, licensed by Beckhoff Automation GmbH.

1.1.3 Limitation of liability

All components of this product described in the original operating instructions are delivered in a hardware and software configuration, depending on the application requirements. Modifications and changes to the hardware or software configuration that go beyond the documented options are prohibited and nullify the liability of Beckhoff Automation GmbH & Co. KG.

The following is excluded from the liability:

- Failure to comply with this documentation
- Improper use
- Use of untrained personnel
- Use of unauthorized spare parts

1.1.4 Copyright

© Beckhoff Automation GmbH & Co. KG, Germany

The copying, distribution and utilization of this document as well as the communication of its contents to others without express authorization is prohibited. Offenders will be held liable for the payment of damages.

We reserve all rights in the event of registration of patents, utility models and designs.

1.2 Version numbers



Provision of revision levels

On request we can send you a list of revision levels for changes to the documentation.

- Send your request to: motion-documentation@beckhoff.de

Origin of the document

This documentation was originally written in German. All other languages are derived from the German original.

Product features

The valid product features are always those specified in the current documentation. Further information given on the product pages of the Beckhoff homepage, in emails or in other publications is not authoritative.

1.3 Scope of the documentation

Apart from these operating instructions, the following documents are part of the overall documentation:

Document	Definition
AL8000 Translation of the original instructions	Description of the mechanical and electrical characteristics as well as all the information required for operating the motors

1.4 Staff qualification

This documentation is aimed at trained specialists working in control technology and automation who have knowledge of the applicable and required standards and directives.

Specialists must have knowledge of drive technology and electrical equipment as well as knowledge of safe working on electrical systems and machines. This includes knowledge of proper setup and preparation of the workplace as well as securing the working environment for other persons.

The documentation published at the time must be used for each installation and commissioning. The products must be used in compliance with all safety requirements, including all applicable laws, regulations, provisions and standards.

Instructed person

Instructed persons have a clearly defined task area and have been informed about the work to be carried out. Instructed persons are familiar with:

- the necessary protective measures and protective devices
- the intended use and risks that can arise from use other than for the intended purpose

Trained person

Trained persons meet the requirements for instructed persons. Trained persons have additionally received training from the machine builder or vendor:

- machine-specific or
- plant-specific

Trained specialists

Trained specialists have received specific technical training and have specific technical knowledge and experience. Trained specialists can:

- apply relevant standards and directives
- assess tasks that they have been assigned
- recognize possible hazards
- prepare and set up workplaces

Qualified electricians

Qualified electricians have comprehensive technical knowledge gained from a course of study, an apprenticeship or technical training. They have an understanding of control technology and automation. They are familiar with relevant standards and directives. Qualified electricians can:

- independently recognize, avoid and eliminate sources of danger
- implement specifications from the accident prevention regulations
- assess the work environment
- independently optimize and carry out their work

1.5 Safety and instruction

Read the contents that refer to the activities you have to perform with the product. Always read the chapter For your safety in the documentation. Observe the warning notes in the chapters so that you can handle and work properly and safely with the product.

1.6 Explanation of symbols

Various symbols are used for a clear arrangement:

- ▶ The triangle indicates instructions that you should execute
- The bullet point indicates an enumeration
- [...] The square parentheses indicate cross-references to other text passages in the document
- [+] The plus sign in square brackets indicates ordering options and accessories

1.6.1 Pictograms

In order to make it easier for you to find text passages, pictograms and signal words are used in warning notices:

DANGER

Failure to observe will result in serious or fatal injuries.

WARNING

Failure to observe may result in serious or fatal injuries.

CAUTION

Failure to observe may result in minor or moderate injuries.



Notes

Notes are used for important information on the product. The possible consequences of failure to observe these include:

- Malfunctions of the product
- Damage to the product
- Damage to the environment



Information

This sign indicates information, tips and notes for dealing with the product or the software.



Examples

This symbol shows examples of how to use the product or software.



QR-Codes

This symbol shows a QR code, via which you can watch videos or animations. Internet access is required in order to use it.

You can read the QR code, for example, with the camera of your smartphone or tablet. If your camera doesn't support this function you can download a free QR code reader app for your smartphone. Use the Appstore for Apple operating systems or the Google Play Store for Android operating systems.

If you cannot read the QR code on paper, make sure that the lighting is adequate and reduce the distance between the reading device and the paper. In the case of documentation on a monitor screen, use the zoom function to enlarge the QR code and reduce the distance.

1.7 Beckhoff Services

Beckhoff and its international partner companies offer comprehensive support and service. A detailed overview of our worldwide technical support is online available at [global availability](#).

Web: www.beckhoff.com/en-en/support/global-availability/

1.7.1 Support services

The Beckhoff Support offers technical advice on the use of individual Beckhoff products and system planning. Our support engineers provide competent support whether the customer has general questions or needs help with a specific installation.

Hotline: +49 5246 963-157

Mail: support@beckhoff.com

Web: www.beckhoff.com/en-en/support/our-support-services/

1.7.2 Training offerings

We offer worldwide training courses for our products and technologies, always concentrating on direct local resources for our customers. Please note that we offer both traditional classroom and online training courses to best suit your needs.

Hotline: +49 5246 963-5000

Mail: training@beckhoff.com

Web: www.beckhoff.com/en-en/support/training-offerings/

1.7.3 Service offerings

Our experts stand ready to provide support worldwide in all areas of after-sales service.

Hotline: +49 5246 963-460

Mail: service@beckhoff.com

Web: www.beckhoff.com/en-en/support/our-service-offerings/

1.7.4 Headquarters Germany

Beckhoff Automation GmbH & Co. KG
Hülshorstweg 20
33415 Verl, Germany

Phone: +49 5246 963-0

Mail: info@beckhoff.com

Web: www.beckhoff.com/en-en/

A detailed overview of our worldwide locations is online available at [global presence](#).

Web: www.beckhoff.com/en-en/company/global-presence/

1.7.5 Downloadfinder

Our download finder contains all the files we offer for download: from our application reports to our technical documentation and configuration files.

Web: www.beckhoff.com/dokumentationen

2 For your safety

Read this chapter containing general safety information. The chapters in these operating instructions also contain warning notices. Always observe the safety instructions for your own safety, the safety of other persons and the safety of the product.

When working with control and automation products, many dangers can result from careless or incorrect use. Work particularly thoroughly, not under time pressure and responsibly towards other people.

2.1 General safety instructions

This chapter provides you with instructions on safety when handling the product. This product is not capable of stand-alone operation and is therefore categorized as an incomplete machine. The product must be installed in a machine or plant by the machine manufacturer. Read the documentation prepared by the machine manufacturer.

2.1.1 Before operation

Protective equipment

Do not remove or bypass any protective devices. Check all protective devices before operation. Make sure that all emergency switches are present at all times and can be reached by you and other people. People could be seriously or fatally injured by unprotected machine parts.

Danger from magnetic fields

Magnetic fields on individual components of the AL8000 linear servomotors pose a risk to:

- persons with cardiac pacemakers or implanted or external defibrillators
- persons with magnetically conducting implants
- magnetic data storage devices, chip cards with magnetic strips and other electronic devices

Maintain a safety distance to all magnetic parts and prevent direct contact between magnetic parts and parts that are sensitive to interference.

Observe the requirements of BGV B 11 for electromagnetic fields (Germany) and applicable national regulations in other countries.

Danger due to magnetic attraction

The magnetic plates contain permanent magnets and attract other ferromagnetic objects. The high attractive forces cannot be controlled by hand.

Ensure a safety distance of at least 25 cm from the magnetic plate to other ferromagnetic parts, e.g. iron.

Observe the requirements of BGV B 11 for electromagnetic fields (Germany) and applicable national regulations in other countries.

Shut down and secure the machine or plant

Shut down the machine or plant. Secure the machine or plant against being inadvertently started up.

Correctly ground electrical components or modules

Avoid electric shocks due to improper grounding of electrical components or modules. Ground all conductive components according to the specifications in the chapters "Electrical Installation" and "Mechanical Installation".

Keep the immediate environment clean

Keep your workplace and the surrounding area clean. Ensure safe working.

Check safety pictograms

Check whether the designated pictograms are on the product. Replace missing or illegible stickers.

Observe tightening torques

Mount and repeatedly check connections and components, complying with the prescribed tightening torques.

Avoid spalling of the sealing compound due to hard knocks

In case of improper use or due to hard knocks, the sealing compound can spall and the product can be damaged.

Use the original packaging only

Use the original packaging for dispatch, transportation, storage and packing.

2.1.2 During operation

Do not work on live electrical parts

Ensure that the protective conductor is connected properly. Measure the voltage on the DC link test contacts DC+ und DC-. Do not work on the linear motor until the voltage has dropped below 50 V DC. Never loosen electrical connections when live. Disconnect all components from the mains and secure them against being switched on again.

Do not touch hot surfaces

Check the cooling of the surfaces with a thermometer. Do not touch the components during and immediately after operation. Allow the components to cool sufficiently after switching off.

Avoid overheating

Activate and monitor the temperature contact of the motor. Provide for sufficient cooling. Switch off the motor immediately if the temperature is too high.

Do not touch any moving or rotating components

Do not touch any moving or rotating components. Fasten all parts or components on the machine or plant.

2.1.3 After operation

De-energize and switch off components before working on them

Check the functionality of all safety-relevant devices. Secure the working environment. Secure the machine or plant against being inadvertently started up. Observe the chapter: "Decommissioning".

3 Product overview

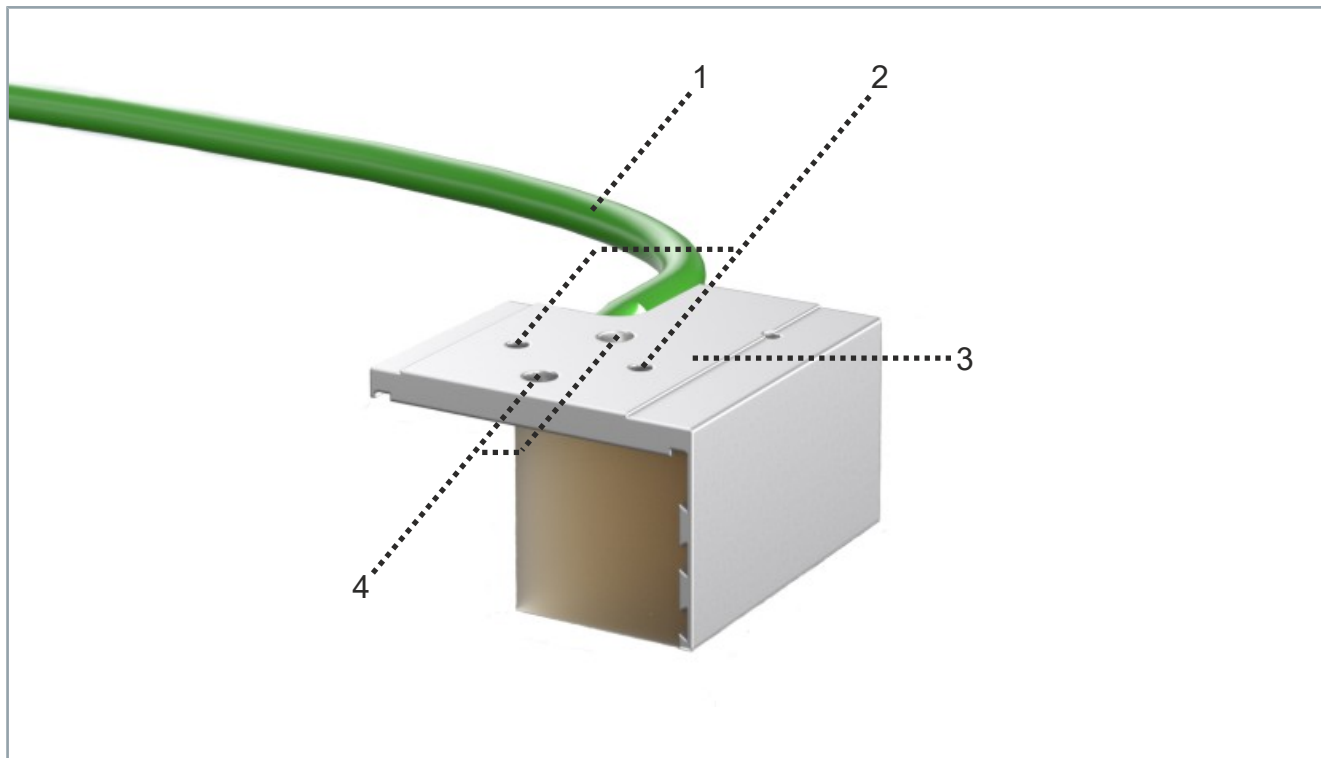

Item number	Explanation
1	Cable
2	Thread for mounting on the machine carriage
3	Mounting plate
4	Holes for locating pins

3.1 Name plate



Item number	Explanation
1	Article name
2	Article description
3	Order number
4	BTN = B eckhoff- T raceability- N umber
5	CE conformity
6	WEEE conformity
7	UKCA conformity
8	Data matrix code; BIC = B eckhoff I dentification C ode

3.2 Type key

AL8200-000z-0000	Ordering option
AL8200	Product area Magnetic encoder system for linear motors
000z	Connection technology 0 = without connector plug and 3 m cable 1 = with connector plug and 0.5 m cable
-0000	not used

3.3 Ordering options

Ordering options are defined via the type key. The listed components cannot be retrofitted.

3.3.1 Connection cable

You have the option of ordering the AL8200 MES with a pre-assembled connection cable with open ferrules or with a plug.

3.3.1.1 Ferrules

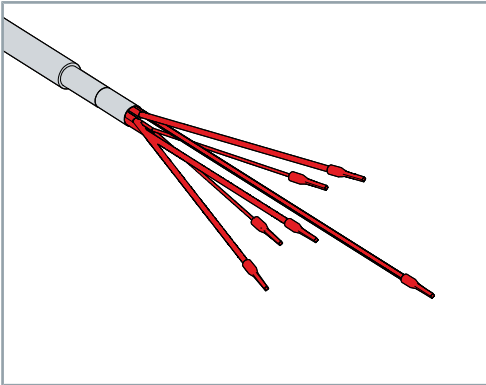

If you do not require a plug, you can order the connection cable with ferrules.

3.3.1.2 Connector

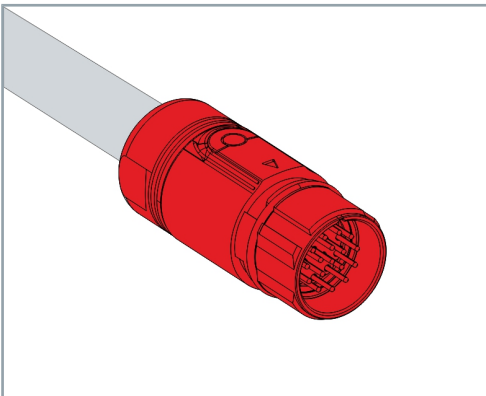

The following connector variant is used:

- EMC encoder coupling M23

3.4 Product characteristics

Magnetic encoder system

AL8200 is used as feedback system for AL8000 linear motors. The installed Hall sensors measure the magnetic field of the magnetic track, so that no additional measuring element needs to be mounted parallel to the magnetic track.

Part-absolute positioning

The alternating magnetic field of the magnetic track generates a sine-cosine waveform. Part-absolute positioning is thus possible within one signal period. This means that a commutation determination only has to be carried out once during initial commissioning. The encoder signals can be used for commutation, speed and position control.

Absolute positioning is not possible with the AL8200.

Analog output signal

The position is forwarded by the AL8200 as an analog SinCos signal to the servo drive. The servo drive must be suitable for reading analog linear feedback systems, such as AX5000.

Accessories for AL8000

AL8200 can only be used as an accessory for the AL8000 linear motors. The installed Hall sensors are adapted to the pole pair distance (24 mm) of the AL8000.

Dust-protected IP64 housing

The MES is fully potted and IP64 protected, making the product dustproof and suitable for temporary submersion.

3.5 Intended use

The AL8200 magnetic encoder system (MES) may only be operated for the purposes as defined in this documentation and under the specified ambient conditions.

The component is installed on the AL8000 linear servomotor. Stand-alone operation of the component is not permitted.



Read the entire drive system documentation:

- this translation of the original instructions
- the translation of the original instructions of the AL8000 linear servomotors
- the entire documentation of the machine of the machine manufacturer

3.5.1 Improper use

Any type of use that exceeds the permissible values from the technical data is regarded as inappropriate and is thus prohibited.

The AL8200 magnetic encoder system (MES) is not suitable for use in the following areas:

- Hazardous areas
- Areas with aggressive environments, for example aggressive gases or chemicals
- Areas with ionizing radiation and nuclear plants
- Aerospace industry

4 Technical data

4.1 Definitions

All details relate to an ambient temperature of 40 °C.

4.1.1 Technical terms

This chapter provides information on various technical terms and their meaning.

Signal period

Duration/distance of a signal period.

Accuracy

Maximum deviation between the set position and the actual position.

Repeatability

Degree of accuracy by which the positioning accuracy can be reduced during a repeated movement.

Resolution

Indicates the smallest position increment.

4.2 Properties

Name	Value / property
Signal period	Pole pair distance 24 mm
Output signal	Analog signal 1 V _{pp} , sine-cosine
Termination resistor	R = 120 Ω
Accuracy	< 100 μm The prerequisite is the precise installation of the magnetic plates with an accuracy of ± 20 μm and offset, phase and amplitude compensation.
Repeatability	< 50 μm
Resolution	5...10 μm
Power supply	5 V DC
Connection cable	8-core with twisted pairs material PUR UL-certified outer diameter 6.8 ± 0.2 mm

4.3 Dimensional drawings

• All figures in millimeters

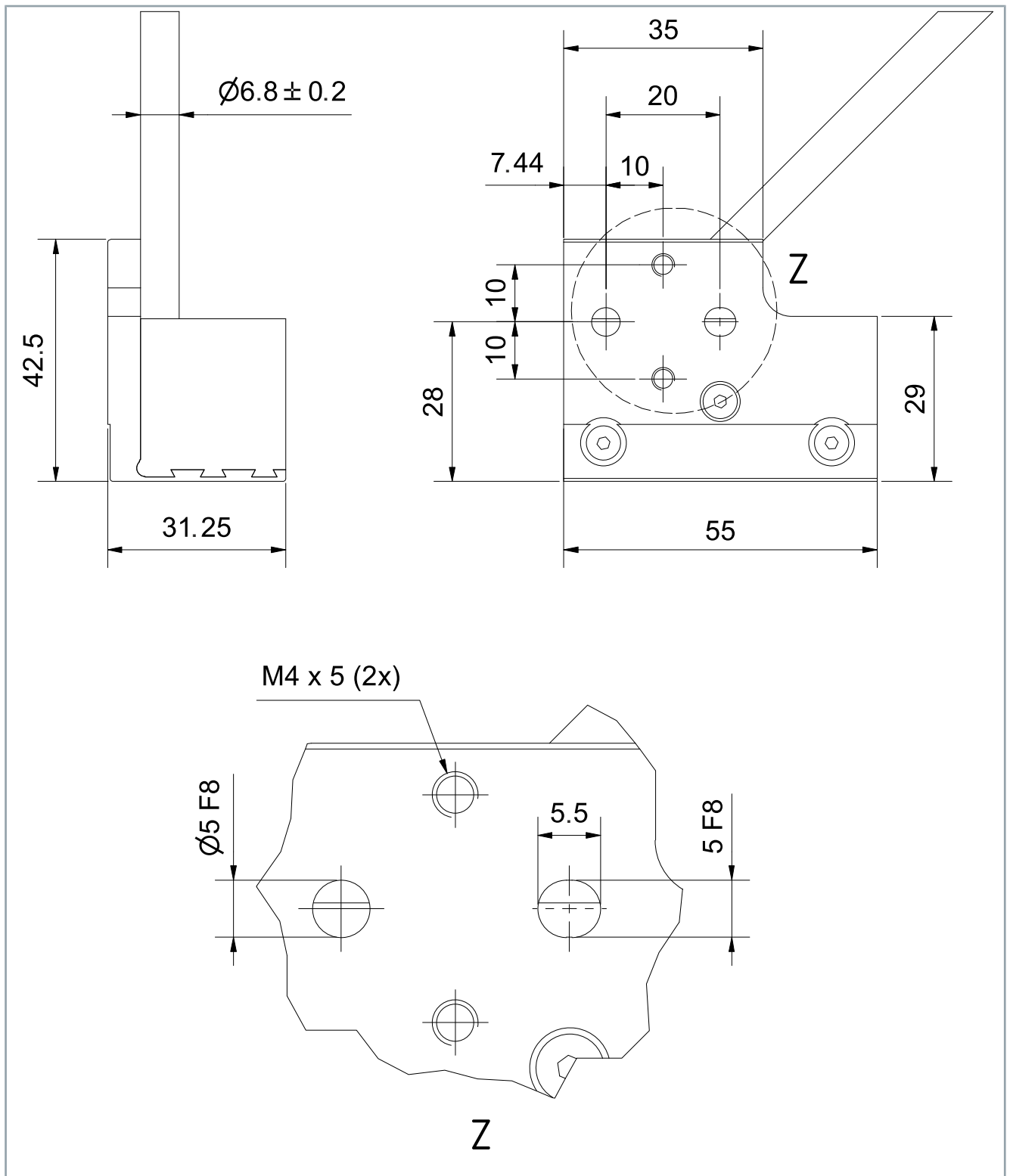

5 Scope of supply



Check the scope of supply for missing or damaged parts

Check your delivery for completeness. If any parts are missing or became damaged during transport, contact the carrier, vendor or our service department immediately.

Check the shipment for the following contents:



The standard scope of supply includes:

- Magnetic Encoder System (MES)

5.1 Packaging

The magnetic encoder system (MES) is packaged individually.

Instructions for handling are printed on the packaging:

Symbol	Explanation
	This is the correct position for the packaging.
	Protect the packaging against wetness.
	The contents are fragile.

6 Transport and storage



Avoid damage to the encoders and resulting loss of warranty

Observe the conditions and the following chapters on transport and storage.

Failure to observe the conditions may result in damage to the magnetic encoder system and void the warranty.

6.1 Conditions

During transport and storage, ensure that the magnetic encoder systems are not damaged. Observe the specifications in the following chapters and comply with the following conditions:

- Climate category: 3K3 according to EN 60721
- Temperature: -25 °C to +70 °C, maximum fluctuation 20 K per hour
- Humidity: relative humidity 5 % to 95 %, no condensation
- Use of suitable means of transport
- Use of the vendor's original packaging

Product designation	Dimensions individual packaging [mm]
AL8200-0000-0000	390x217x127
AL8200-0001-0000	240x140x50

6.2 Transport

The following options are available for transporting a single encoder system:

- Without tools, by hand

6.3 Long-term storage



Observe storage conditions

Unlimited storage of magnetic encoder systems possible. Ensure that low air humidity is maintained when storing feedback systems.

Failure to observe this may result in changes in the properties of the cables or the sealing compound.

Perform recurring inspections

Check the encoder systems for proper condition every six months.

Damage to the encoder system or maintenance work not carried out on the machine / system will affect the service life of the installed components and parts.

Prevent the formation of condensation

Keep the ambient temperature constant. Avoid solar radiation and high air humidity.

Condensation water can lead to damage during subsequent operation, calcification or rust formation.

You have the option of storing the magnetic encoder systems for a short or longer period of time. We always recommend storing components in the original packaging. Observe the conditions from the chapter: "Transport and storage", [Page 25].
Ensure a vibration-free storage room.

7 Mechanical installation

All work should be carried out with great care and without time pressure.

7.1 Requirements

When designing and dimensioning the machine or system, observe the basic requirements for mounting the magnetic encoder system.

7.2 Assembly



Use only the drill holes shown

Use only the drill holes shown for the assembly or for other activities described in these operating instructions. Drill holes not shown may be present, for example, for production purposes.

Failure to do so will result in damage to the magnetic encoder system or the motor.



Clean the mounting surfaces

Make sure that all mounting surfaces are oil-free, grease-free and unpainted. Remove any dirt or dust.

Observe the mounting sequence

Mount the AL8200 magnetic encoder system only after all steps of the AL8000 assembly have been completed.

Observe the screw requirements

Observe the minimum and maximum screw depths of the screws. Information on the screw depths can be found in the individual sections during mounting. Please observe the permissible torques and standards.

The MES is installed behind or in front of the primary part, so that it moves with the primary part over the secondary part.

Screw quality = strength class 8.8	
Screw	M4
Screw depth	4 - 4.5 mm
Tightening torque	2 Nm
Locating pin according to ISO 8734	
Nominal diameter	5 mm
Screw depth	4 - 4.5 mm

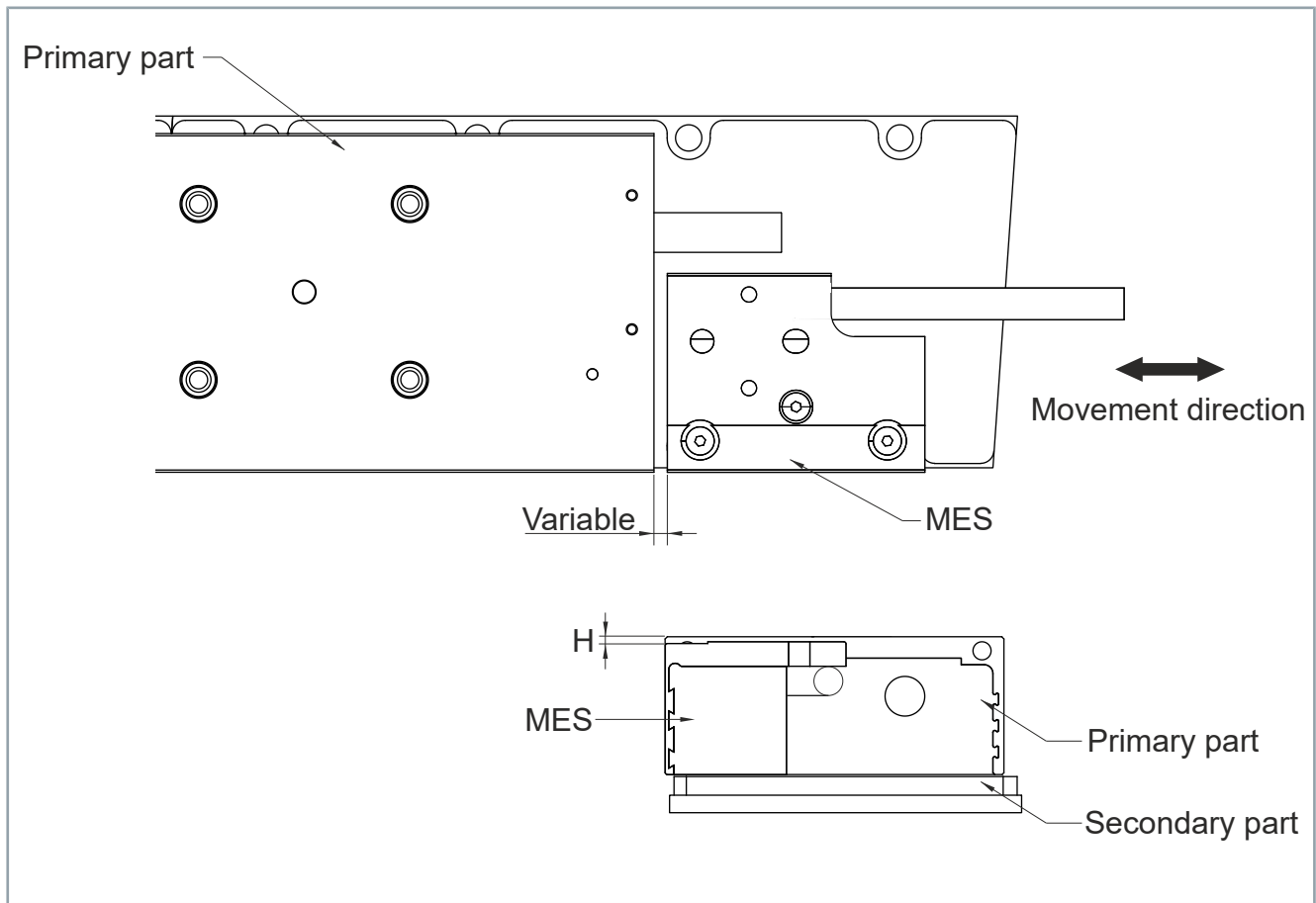

	Distance to the top side of the primary part	Rotation with respect to the movement direction	Distance to the outside edge of the primary part
	H in mm	degree	mm
AL802x	0	0.5	±1
AL804x	0		
AL806x-0	1		
AL806x-1	3		

7.3 Verification

⚠ WARNING

Incorrect mounting of the MES can lead to serious injury or damage

Improper mounting can result in incorrect position determination of the AL8000 linear motor and cause serious injury or damage to the machine.

- Make sure that the AL8200 magnetic encoder system has been correctly mounted according to the manufacturer's specifications.

- ▶ After assembly, check the installed components for good hold and straight alignment.
- ▶ Make sure that the MES does not grind or touch any point along the travel path.

8 Electrical installation

8.1 Connection technology

Beckhoff supplies pre-assembled power and feedback lines. For the selection of the cables required, refer to the Beckhoff documentation for the connecting cables. In the documentation you will find a complete overview of the available cables and information on the technical data.



Maximum number of mating cycles

The information on maximum mating cycles can be found in the respective data sheets at www.beckhoff.com.

8.1.1 Cables



Do not lay the cable in drag chains

The cable of the AL8200 is firmly encapsulated with the sensor head. It is part of the wear-free product. Do not lay the cable in a drag chain.

A limited service life or damage to the magnetic encoder system is the result. Non-compliance will void the warranty and other claims for damages.

Avoid soiling and damage

When connecting the coupling and the plug, make sure that the poles and the inside of the component are not soiled or damaged.

Failure to do so may adversely affect the function of the connections.



Hint for trouble-free application and assembly:

- Wiring in accordance with applicable regulations and standards
- Use of pre-assembled and shielded Beckhoff cables

Beckhoff offers pre-assembled cables for faster and flawless installation of the magnetic encoder system. These cables are tested with regard to the material used, shielding and connection type. The use of other cables can cause unexpected malfunctions and result in exclusion of warranty.

8.2 Connector assignment

Beckhoff offers various power connectors and feedback connectors. All plugs are IP65 rated.

The following tables show the connector assignment on the motor side:

8.2.1 AL8200-0000-0000

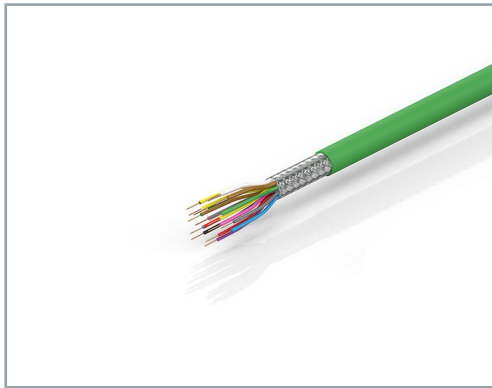

- 3 m connection cable

Assignment (color code)	
Color	Function
brown	SIN +
white	SIN -
gray	COS +
pink	COS -
red	+ 5 V _{DC}
blue	GND
green	+ 5 V sense
yellow	GND sense
Shield	PE / GND

8.2.2 AL8200-0001-0000

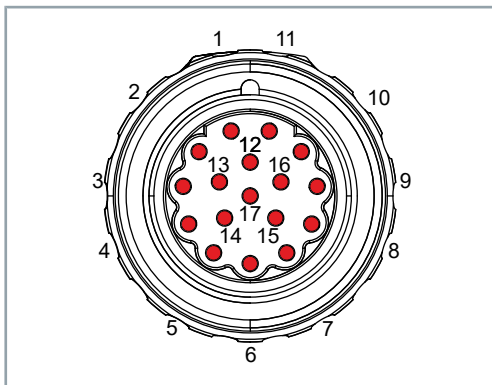

- 0.5 m connection cable
- 17-pin M23 connector; corresponds to connector service pack ZS4000-2051
- Compatible motor cable on AX5000: ZK4510-00x0-xxxx

Plug assignment ZS4000-2051	
Contact	Function
1	SIN -
2	GND
3	COS -
4	+5 VDC
9	SIN +
10	GND sense
11	COS +
12	+5 V sense
Housing	Shield

9 Commutation and commissioning

9.1 Commutation

The Magnetic Encoder System (MES) serves as feedback for linear motors of the AL8xxx series. It is to be used exclusively for operation on a servo drive.

Linear feedback systems are required for the commutation and the detection of the velocity and position of brushless linear motors. Such feedback systems consist of a reader head and a scale installed parallel to the travel path. The AL8200 works directly on the magnetic plates of the linear motor, eliminating the need for an additional scale. It detects the magnetic field of the permanent magnets of the magnetic plates and supplies the encoder signals to the servo drive. Since the MES is a part-absolute feedback system, no wake & shake is required in order to determine the commutation angle at machine start-up. The MES supplies one sine oscillation per logical motor revolution. A logical motor revolution is equivalent to the distance between two homopolar magnets, i.e. between two north poles. The attainable accuracy of ± 0.1 mm is sufficient for simple positioning tasks and depends to a large extent on the mechanical accuracy and position of the magnets along the travel path. Since no scale has to be installed, the MES is an inexpensive feedback solution for linear motors.



Detailed information on the commutation of the AL8000 linear motor in conjunction with the AL8200 MES can be found in chapter 9.6.2 of the AX5000 System Manual.

9.2 Commissioning



Exemplary commissioning

The procedure for commissioning is described as an example. A different method may be appropriate or necessary, depending on the application of the components.



Requirements for commissioning

Before commissioning the AL8200 MES, the following steps must be completed:

- Mechanical and electrical installation
- Installation of the [T5950 | TwinCAT 3 Drive Manager 2](#)

The commissioning of the AL8200 MES is to be carried out as follows:

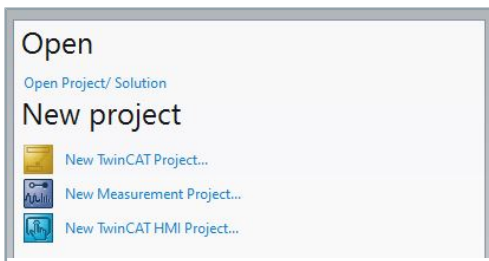

- ▶ Create new TwinCAT project

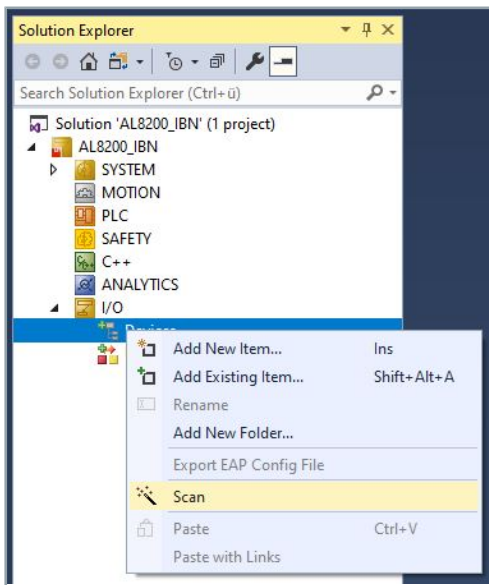

- ▶ If connected to target system, scan devices

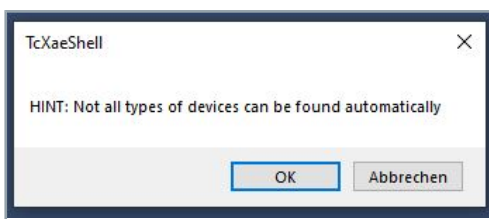

- ▶ Accept message "HINT: Not all types of devices can be found automatically" with "ok"

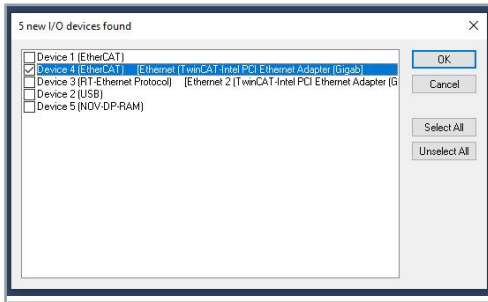

► Select Ethernet port

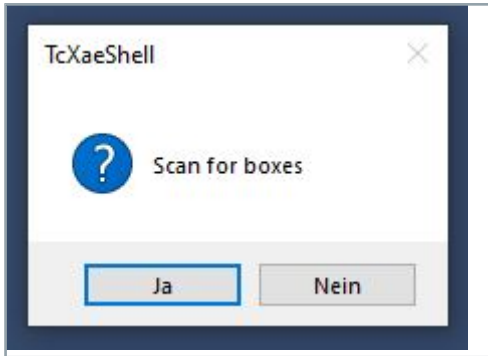

► Confirm the scan prompt with "yes"

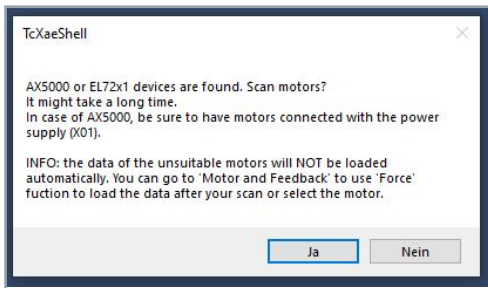

► AX5000 Motor scan Select "no" button (linear motors cannot currently be scanned)

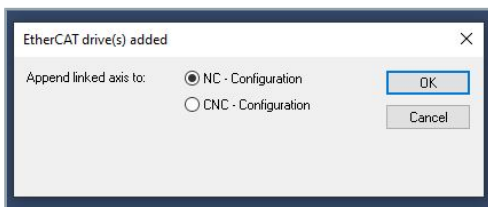

► Select NC or CNC axis

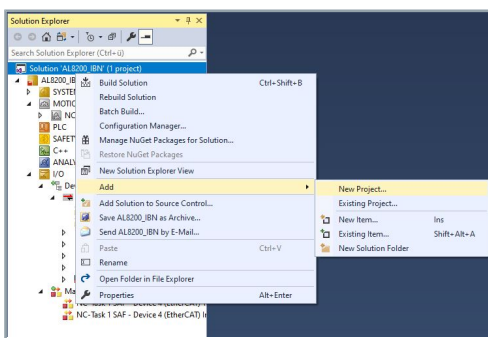

► Add new project

Commutation and commissioning

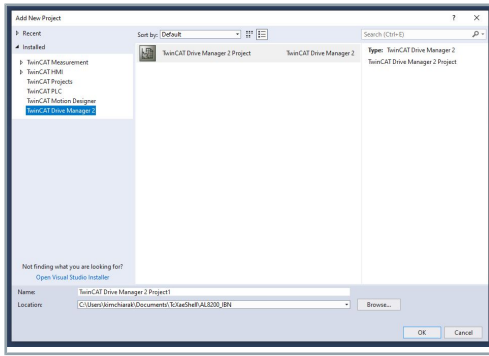

► Select new Drive Manager 2 project

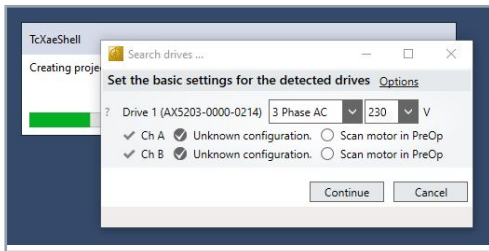

► Confirm supply voltage query and motor scan with "Continue"

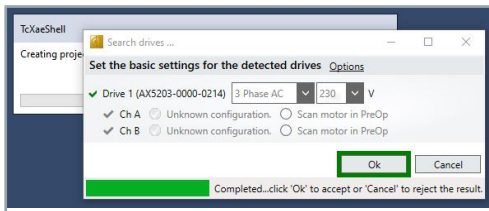

► Click "OK"

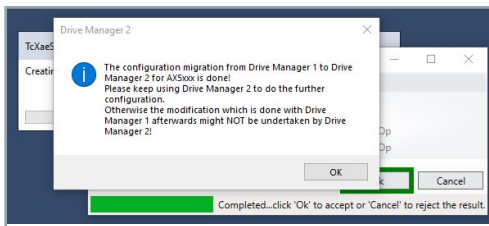

► Confirm upcoming message with "OK"

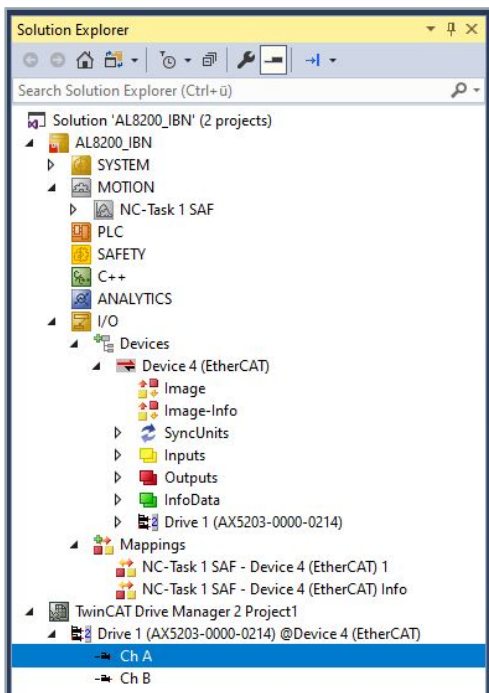

► Open the relevant channel in the Solution Explorer under the Drive Manager 2 project

Commutation and commissioning

► The Drive Manager 2 opens



► Select the AL8000 linear motor under "Motor/Select"

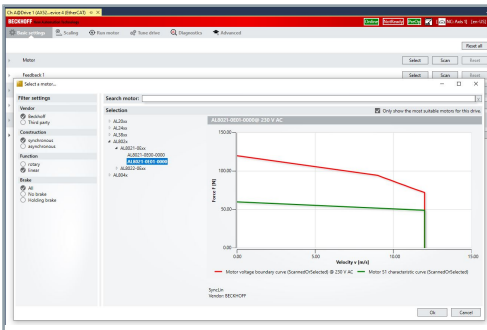

► In the "Load" submenu, parameterize and save feedrate and mass

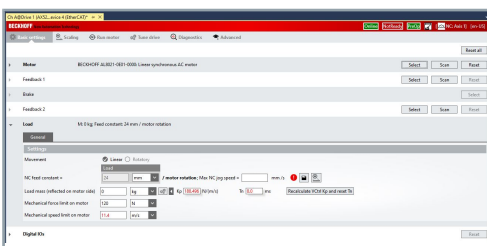

► Select feedback (Beck#AL8200MES-5V-1Vpp)

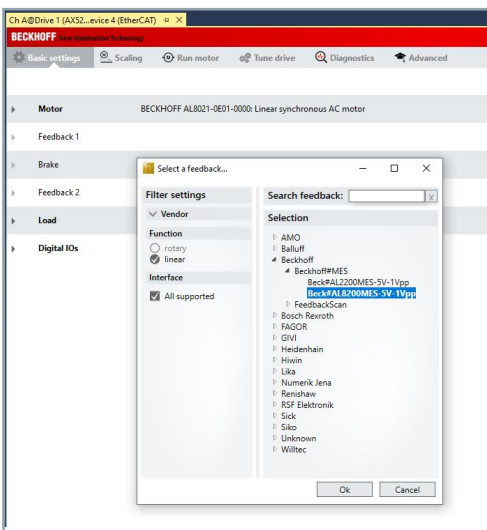

► Determine direction of rotation and commutation angle in parameter P-0-0166 (see also AX5000 System Manual, chapter 9.6.2)

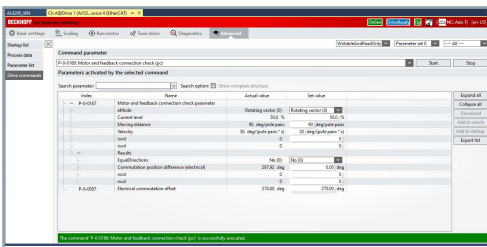

► "Equal directions" / "Yes"
The value for "Commutation position difference" should now lie within the range: $355...360 = 0...5$.

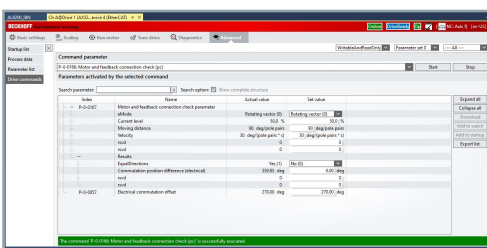

Commutation and commissioning

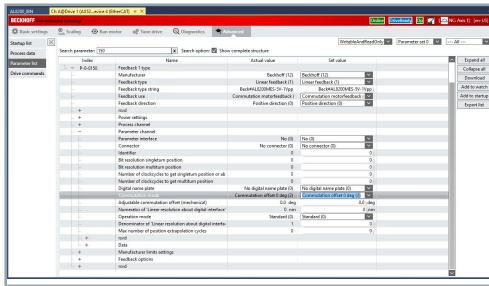

- ▶ Set "Commutation mode" in parameter P-0-0150 to "Commutation offset 0 deg (2)"

The axis can then be moved, e.g. for controller optimization.

10 Maintenance and cleaning

WARNING

Refrain from cleaning work during operation

Carrying cleaning work during operation can lead to serious or fatal injuries.

- For cleaning work, bring the connected motors and the machine into a safe, de-energized state.



Do not immerse or spray the encoder system

Wipe off the encoder system only with a cleaning agent and a cloth.

Due to impermissible solutions, cleaning by immersion can lead to damage to the surface and the encoder system as well as to leak-tightness problems.

Magnetic encoder systems are basically maintenance-free. Extreme soiling can lead to failure.

10.1 Cleaning agents

Clean the components carefully with a damp cloth or a brush.

Use grease-dissolving and non-aggressive cleaning agents such as isopropanol for cleaning. You will also receive information about non-approved cleaning agents.

10.1.1 Not applicable

Cleaning agents	Chemical formula
Aniline hydrochloride	$C_6H_5NH_2HCl$
Bromine	Br_2
Sodium hypochlorite; bleaching solution	$NaClO$
Mercury (II) chloride	$HgCl_2$
Hydrochloric acid	HCl

11 Accessories



Use accessories with UL approval

Accessories with UL approval are also required for operating the AL8000 linear drive system in the USA or Canada.

Further and more detailed information on accessories can be found on the Beckhoff homepage.

11.1 ZK4510-0020-xxxx



The pre-assembled encoder connection cable is used to connect the AX5000 servo drive and the AL8200 magnetic encoder system.

12 Decommissioning

Disassembly may only be carried out by qualified and trained personnel.

Read the chapter Documentation notes.

When disposing of electronic waste, make sure that you dispose of it in accordance with the regulations applicable in your country. Read and follow the instructions for proper disposal.

12.1 Disassembly

Removal of the magnetic encoder system from the machine:

- ▶ Disconnect the machine from the power supply
- ▶ Disconnect MES connection cable from AX5000
- ▶ Push the machine carriage to one side and mechanically secure it against uncontrolled movements
- ▶ Unscrew and remove the bolts
- ▶ Remove magnetic encoder system

12.2 Disposal

Depending on your application and the products used, ensure the professional disposal of the respective components:

Cast iron and metal

Dispose of cast and metal parts as scrap metal for recycling.

Cardboard, wood and foam polystyrene

Dispose of packaging materials made of cardboard, wood or foam polystyrene in accordance with the regulations.

Plastics and hard plastics

You can recycle parts made of plastic and hard plastic via the recycling depot or re-use them depending on the component designations and markings.

Oils and lubricants

Dispose of oils and lubricants in separate containers. Hand over the containers at the used oil collection station.

Batteries and rechargeable batteries

Batteries and rechargeable batteries may also be marked with the crossed-out trash can symbol. You must separate these components from the waste and are legally obliged to return used batteries and rechargeable batteries within the EU. Observe the relevant provisions outside the area of validity of the EU Directive 2006/66/EC.



Electronic components

Products marked with a crossed-out waste bin must not be disposed of with general waste. Electronic components and equipment must be disposed of properly. The national regulations for the disposal of electrical and electronic equipment must be observed.

12.2.1 Returning to the vendor

In accordance with the WEEE-2012/19/EU directives, you can return used devices and accessories for professional disposal. The transport costs are borne by the sender.

Send the used devices with the note "For disposal" to:

Beckhoff Automation GmbH & Co. KG
"Service" Building
Stahlstrasse 31
D-33415 Verl

In addition, you have the option to contact a local certified specialist company for the disposal of used electrical and electronic appliances. Dispose of the old components in accordance with the regulations applicable in your country.

13 Guidelines and Standards

Test procedures and certifications vary by product. Beckhoff linear servomotors of the AL8000 series are certified and tested according to the following directives and standards.

13.1 Standards

EN IEC 61800-3:2018

"EMC requirements including special test procedures for drive systems and machines with drive systems included"

RoHS: EN IEC 63000:2018

"*Technical documentation for the assessment of electrical and electronic products with respect to the restriction of hazardous substances*"

13.2 Guidelines

2014/35/EU

Low Voltage Directive



2014/30/EU

EMC Directive

2011/65/EU

RoHS Directive

13.3 Test centers

	<p>The motors do not fall within the scope of the Machinery Directive. However, Beckhoff products are designed and evaluated in full compliance with all relevant regulations for personal safety and use in a machine or system.</p>
	<p>The motors meet all the requirements of the UK economic area. These include England, Wales and Scotland.</p>

13.4 EU conformity



Provision

Beckhoff Automation GmbH & Co KG will be pleased to provide you with EU declarations of conformity and manufacturer's declarations for all products on request.

Please send your request to: info@beckhoff.com

13.5 CCC conformity



Export to Chinese Economic Area

Beckhoff encoder system of the AL8200 series are not subject to the **C**hina **C**ompulsory **C**ertificate; CCC. The products are exempt from this certification and can be exported to the Chinese economic area.

14 Notes

More Information:
www.beckhoff.com

Beckhoff Automation GmbH & Co. KG
Hülshorstweg 20
33415 Verl
Germany
Phone: +49 5246 9630
info@beckhoff.com
www.beckhoff.com

