

BECKHOFF

CB4052

Manual

rev. 1.4

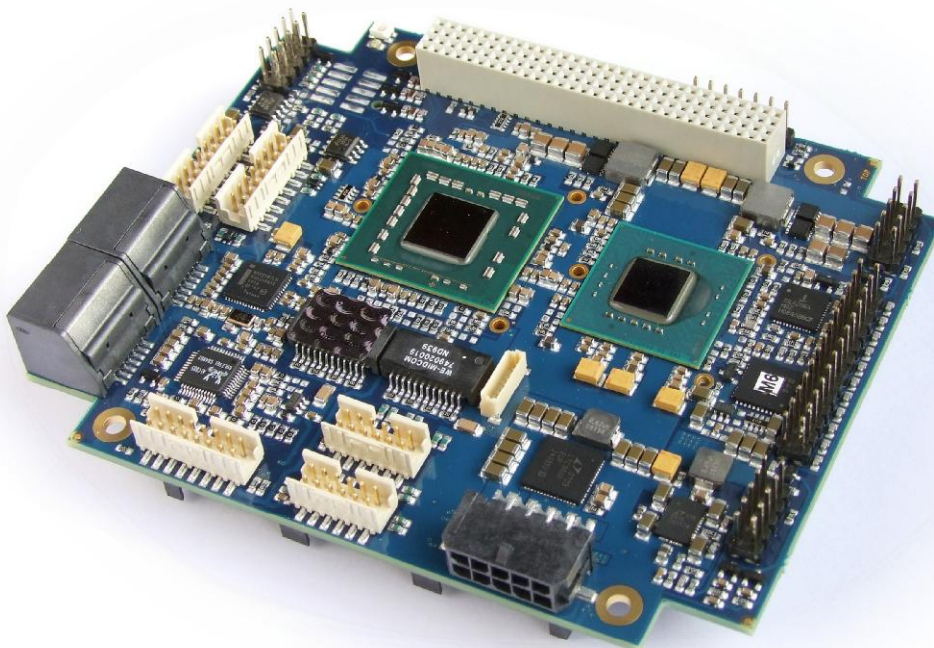

Contents

0	Document History	5
1	Introduction	6
1.1	Notes on the Documentation	6
1.1.1	Liability Conditions	6
1.1.2	Copyright	6
1.2	Safety Instructions	7
1.2.1	Disclaimer	7
1.2.2	Description of Safety Symbols	7
1.3	Essential Safety Measures	8
1.3.1	Operator's Obligation to Exercise Diligence	8
1.3.2	National Regulations Depending on the Machine Type	8
1.3.3	Operator Requirements	8
1.4	Functional Range	9
2	Overview	10
2.1	Features	10
2.2	Specifications and Documents	12
3	Connectors	13
3.1	Connector Map	14
3.2	Power Supply	15
3.3	System	16
3.4	Memory	17
3.5	PC/104-Plus Bus	20
3.6	PCI/104-Express Bus	22
3.7	VGA	24
3.8	LCD	25
3.9	USB	27
3.10	LAN	28
3.11	Audio	29
3.12	SATA Interfaces	30
3.13	Parallel Interface LPT	31
3.14	Serial Interface COM1	32
3.15	Serial Interface COM2	33
3.16	SMBus	34
3.17	Monitoring Functions	35
4	Status LEDs	36
4.1	HD LED	36
4.2	RGB LED	37
5	BIOS Settings	38
5.1	Remarks for Setup Use	38
5.2	Top Level Menu	38
5.3	Standard CMOS Features	39
5.3.1	IDE Channel 0 Master/Slave	40
5.4	Advanced BIOS Features	41
5.4.1	CPU Feature	43
5.4.2	Hard Disk Boot Priority	44
5.5	Advanced Chipset Features	45

Contents

5.5.1	PCI Express Root Port Function	46
5.6	Integrated Peripherals	47
5.6.1	OnChip IDE Devices	48
5.6.2	SuperIO Devices	50
5.6.3	USB Device Setting.....	51
5.7	Power Management Setup.....	52
5.7.1	PCI Express PM Function	54
5.7.2	Intel DTS Feature	55
5.8	PnP/PCI Configuration	56
5.8.1	IRQ Resources.....	58
5.9	PC Health Status.....	59
5.10	Frequency/Voltage Control	60
5.11	Load Fail-Safe Defaults.....	61
5.12	Load Optimized Defaults.....	61
5.13	Set Password	61
5.14	Save & Exit Setup	61
5.15	Exit Without Saving	61
6	BIOS update	62
7	Mechanical Drawing	63
7.1	PCB: Mounting Holes	63
7.2	PCB: Pin 1 Dimensions.....	64
7.3	PCB: Heat Sink	65
8	Technical Data.....	66
8.1	Electrical Data	66
8.2	Environmental Conditions	66
8.3	Thermal Specifications	67
9	Support and Service	68
9.1	Beckhoff's Branch Offices and Representatives	68
9.2	Beckhoff Headquarters.....	68
9.2.1	Beckhoff Support.....	68
9.2.2	Beckhoff Service	68
I	Annex: Post-Codes.....	69
II	Annex: Resources	72
A	IO Range	72
B	Memory Range.....	72
C	Interrupt	72
D	PCI Devices.....	73
E	SMB Devices	73

0 Document History

Version	Changes
0.1	first pre-release
1.0	first complete version
1.1	minor changes
1.2	updated block diagram (BIOS via SPI, ALC885 EOL etc.), emphasized 12 volt power supply, added note concerning PS_ON, minor changes
1.3	added description of status LEDs, added labels to LVDS connector symbols, minor changes
1.4	improved output quality of dimensional drawings



NOTE

All company names, brand names, and product names referred to in this manual are registered or unregistered trademarks of their respective holders and are, as such, protected by national and international law.

1 Introduction

1.1 Notes on the Documentation

This description is only intended for the use of trained specialists in control and automation engineering who are familiar with the applicable national standards. It is essential that the following notes and explanations are followed when installing and commissioning these components.

1.1.1 Liability Conditions

The responsible staff must ensure that the application or use of the products described satisfy all the requirements for safety, including all the relevant laws, regulations, guidelines and standards. The documentation has been prepared with care. The products described are, however, constantly under development. For that reason the documentation is not in every case checked for consistency with performance data, standards or other characteristics. None of the statements of this manual represents a guarantee (Garantie) in the meaning of § 443 BGB of the German Civil Code or a statement about the contractually expected fitness for a particular purpose in the meaning of § 434 par. 1 sentence 1 BGB. In the event that it contains technical or editorial errors, we retain the right to make alterations at any time and without warning. No claims for the modification of products that have already been supplied may be made on the basis of the data, diagrams and descriptions in this documentation.

1.1.2 Copyright

© This documentation is copyrighted. Any reproduction or third party use of this publication, whether in whole or in part, without the written permission of Beckhoff Automation GmbH, is forbidden.

1.2 Safety Instructions

Please consider the following safety instructions and descriptions. Product specific safety instructions are to be found on the following pages or in the areas mounting, wiring, commissioning etc.

1.2.1 Disclaimer

All the components are supplied in particular hardware and software configurations appropriate for the application. Modifications to hardware or software configurations other than those described in the documentation are not permitted, and nullify the liability of Beckhoff Automation GmbH.

1.2.2 Description of Safety Symbols

The following safety symbols are used in this documentation. They are intended to alert the reader to the associated safety instructions.



ACUTE RISK OF INJURY!

If you do not adhere to the safety advise next to this symbol, there is immediate danger to life and health of individuals!



RISK OF INJURY!

If you do not adhere to the safety advise next to this symbol, there is danger to life and health of individuals!



HAZARD TO INDIVIDUALS, ENVIRONMENT, DEVICES, OR DATA!

If you do not adhere to the safety advise next to this symbol, there is obvious hazard to individuals, to environment, to materials, or to data.



NOTE OR POINTER

This symbol indicates information that contributes to better understanding.

1.3 Essential Safety Measures

1.3.1 Operator's Obligation to Exercise Diligence

The operator must ensure that

- the product is only used for its intended purpose
- the product is only operated in sound condition and in working order
- the instruction manual is in good condition and complete, and always available for reference at the location where the products are used
- the product is only used by suitably qualified and authorised personnel
- the personnel is instructed regularly about relevant occupational safety and environmental protection aspects
- the operating personnel is familiar with the operating manual and in particular the safety notes contained herein

1.3.2 National Regulations Depending on the Machine Type

Depending on the type of machine and plant in which the product is used, national regulations governing the controllers of such machines will apply, and must be observed by the operator. These regulations cover, amongst other things, the intervals between inspections of the controller. The operator must initiate such inspections in good time.

1.3.3 Operator Requirements

- Read the operating instructions

All users of the product must have read the operating instructions for the system they work with.

- System know-how

All users must be familiar with all accessible functions of the product.

1.4 Functional Range



NOTE

The descriptions contained in the present documentation represent a detailed and extensive product description. As far as the described motherboard was acquired as an integral component of an Industrial PC from Beckhoff Automation GmbH, this product description shall be applied only in limited scope. Only the contractually agreed specifications of the corresponding Industrial PC from Beckhoff Automation GmbH shall be relevant. Due to several models of Industrial PCs, variations in the component placement of the motherboards are possible. Support and service benefits for the built-in motherboard will be rendered by Beckhoff Automation GmbH exclusively as specified in the product description (inclusive operation system) of the particular Industrial PC.

2 Overview

2.1 Features

The CB4052 is a highly complex computer motherboard in the PC/104™ form factor, complying with the state-of-the-art "PCI/104-Express™" standard. It's based on Intel®'s GS45 chipset combined with the ICH9M-E chip (SFF). Several CPUs are available for this board, all from Intel®'s Core™2 Duo and Celeron® M series. Modern DDR3 technology provides top-notch memory performance, accommodating up to 4 GByte of RAM (DDR3-1066) via SO-DIMM204. PCI bus and PCI-Express are available through the PC/104-Plus and PCI/104-Express (type 1) connectors, respectively, giving system builders a great deal of flexibility as far as expansion cards are concerned. Additional onboard peripheral devices include two serial interfaces, two Gigabit Ethernet interfaces (LAN), four SATA channels, an audio interface (HDA 7.1), eight USB channels and CRT and LVDS/TFT support.

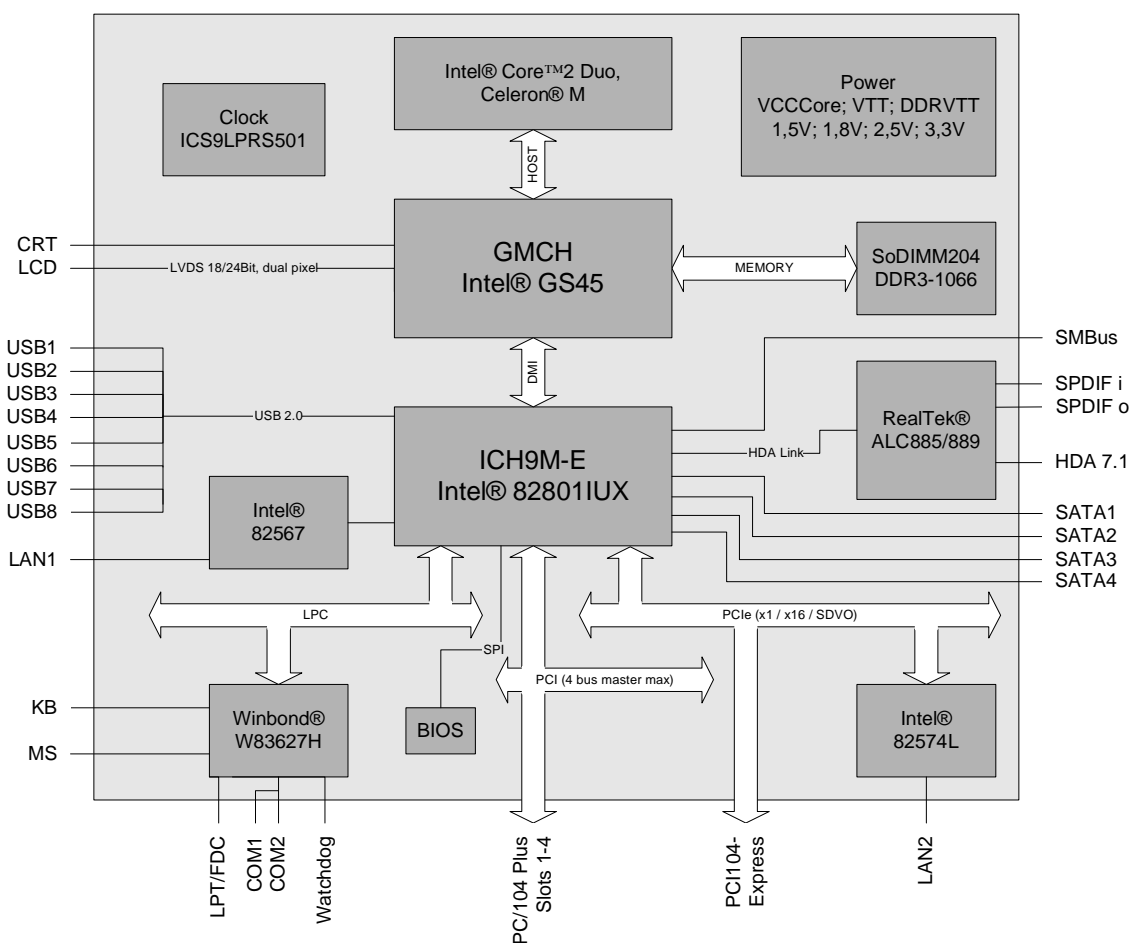

- Processor Intel® Core™2 Duo or Celeron® M
- Chipset Intel® GS45 with integrated graphics and ICH9M-E (SFF)
- SO-DIMM204 socket for one DDR3-1066 module of up to 4 GByte
- Two serial interfaces COM1 and COM2
- Two LAN interfaces Ethernet 10/100/1000 (Base-T)
- Four SATA channels
- PS2 keyboard / mouse interface
- LPT interface
- Eight USB 2.0 interfaces

- AWARD BIOS 6.10
- CRT connection
- LCD connection via LVDS 18/24Bit (dual pixel)
- HDA compatible sound controller with SPDIF in and out
- RTC with external CMOS battery
- 5V and 12V supply voltage
- PCI bus via PC/104-Plus (max. four master devices)
- PCI-Express bus via PCI/104-Express connector, type 1 (x1, x16, SDVO, HDMI etc.)
- Size: 96 mm x 90 (115.5) mm

2.2 Specifications and Documents

In making this manual and for further reading of technical documentation, the following documents, specifications and web-pages were used and are recommended.

- § PC/104™ Specification
Version 2.5
www.pc104.org
- § PC/104-Plus™ Specification
Version 2.0
www.pc104.org
- § PCI104-Express™ Specification
Version 2.0
www.pc104.org
- § PCI Specification
Version 2.3 and 3.0
www.pcisig.com
- § ACPI Specification
Version 3.0
www.acpi.info
- § ATA/ATAPI Specification
Version 7 Rev. 1
www.t13.org
- § USB Specifications
www.usb.org
- § SM-Bus Specification
Version 2.0
www.smbus.org
- § Intel®-Chip Description
Celeron® M, Core™ 2 Duo
www.intel.com
- § Intel® Chipset Description
Intel® 4 Series Express Chipset Family datasheet
www.intel.com
- § Intel® Chip Description
Intel® ICH9 Datasheet
www.intel.com
- § Intel® Chip Description
82574L Datasheet
www.intel.com
- § Winbond® Chip Description
W83627HG
www.winbond-usa.com or www.winbond.com.tw
- § IDT® Chip Description
ICS9LPRS501SKLF Datasheet
www.idt.com
- § Realtek® Chip Description
ALC885/889 Datasheet
www.realtek.com.tw

3 Connectors

This section describes all the connectors found on the CB4052.



CAUTION

For most interfaces, the cables must meet certain requirements. For instance, USB 2.0 requires twisted and shielded cables to reliably maintain full speed data rates. Restrictions on maximum cable length are also in place for many high speed interfaces and for power supply. Please refer to the respective specifications and use suitable cables at all times.

3.1 Connector Map

Please use the connector map below for quick reference. Only connectors on the component side are shown. For more information on each connector refer to the table below.

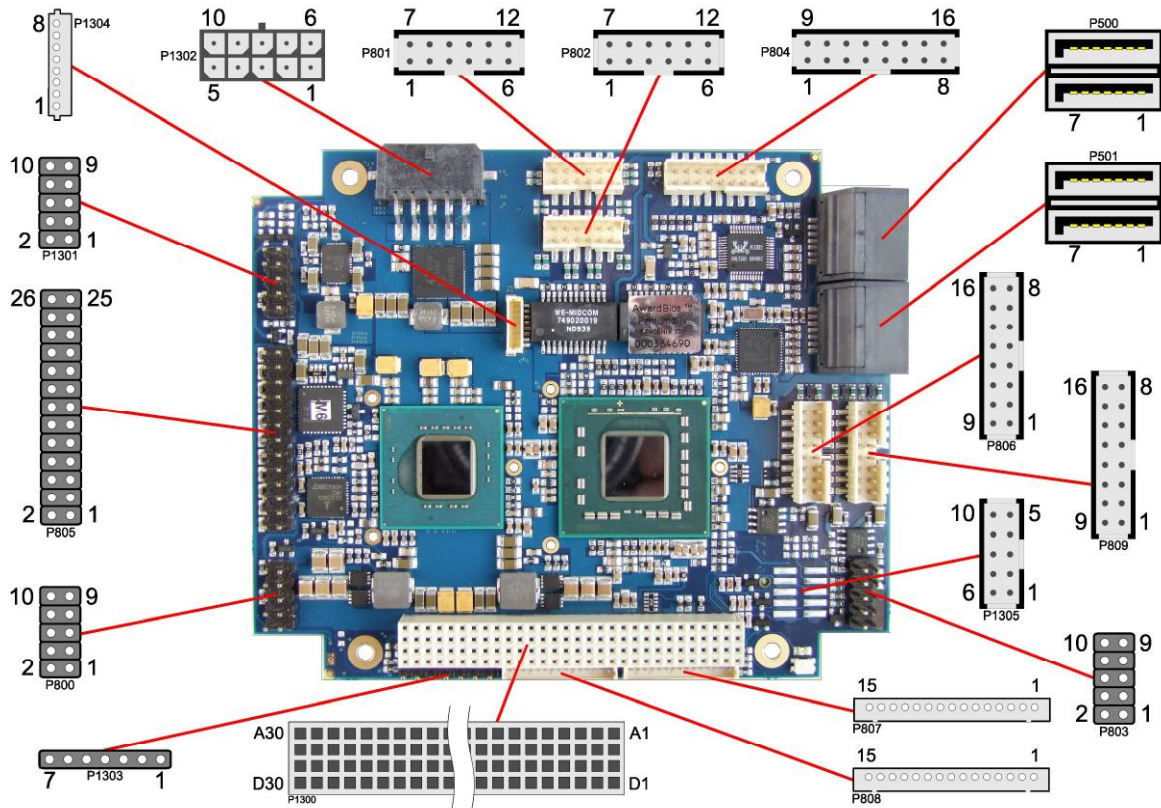

Ref-No.	Function	Page
P500/P501	"SATA Interfaces"	p. 30
U600*	"Memory"	p. 17
P800	"Serial Interface COM1"	p. 32
P801/P802	"LAN"	p. 28
P803	"Serial Interface COM2"	p. 33
P804	"Audio"	p. 29
P805	"Parallel Interface LPT"	p. 31
P806/P809	"USB"	p. 27
P807/P808	"LCD"	p. 25
P1200*	"PCI/104-Express Bus"	p. 22
P1300	"PC/104-Plus Bus"	p. 20
P1301	"System"	p. 16
P1302	"Power Supply"	p. 15
P1303	"SMBus"	p. 34
P1304	"Monitoring Functions"	p. 35
P1305	"VGA"	p. 24

* not in the picture above (cf. bottom side of board)

3.2 Power Supply

The power supply of the hardware module is realized via a 2x5-pin connector (Molex PS 43045-10xx, mating connector: Molex PS 43025-10xx). Both 5V VCC/SVCC and 12V need to be provided. The 12V input can optionally be tied to 5V if 12V is not required by attached peripherals. It cannot, however, be left unconnected.

 **CAUTION**

The CB4052 includes circuitry that will notify an intelligent power supply to shut down if the processor reaches a critical temperature. This is achieved by deasserting the (low-active) PS_ON# signal found on the SM-Bus connector. When PS_ON# is no longer pulled low, an intelligent power supply would take this as a signal to shut down power. For this to work, PS_ON# must be connected to the power supply's PS_ON input. If PS_ON# is not otherwise connected, the CB4052 can be damaged beyond repair if a thermal shutdown event occurs. In rare instances, if power is not shut down, the board will continue to heat up until failure occurs.

 **NOTE**

Since this is a 90 degree connector, the symbol in the drawing below represents the connector face as seen from the side (PCB on bottom) rather than from above.

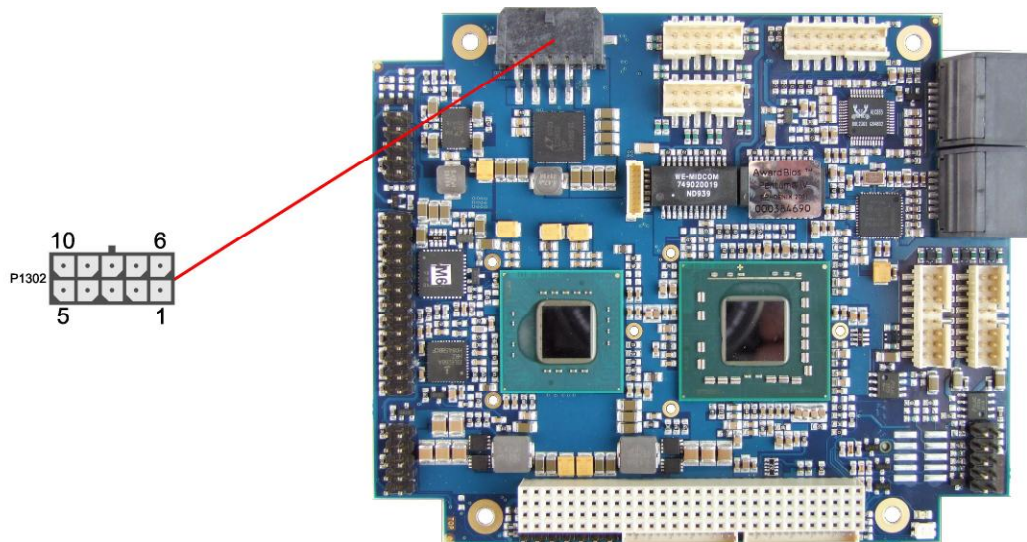

Description	Name	Pin	Name	Description
12 volt supply	12V	1	6	12V
ground	GND	2	7	GND
ground	GND	3	8	SVCC
ground	GND	4	9	GND
5 volt supply	VCC	5	10	VCC

3.3 System

The system connector, which has the main functions that are necessary to start the board, is provided via a standard IDC socket connector with a spacing of 2.54 mm.

This connector supports the following interfaces: PS/2 keyboard, PS/2 mouse, speaker, external RTC-battery and reset of the board.

i **NOTE**

For "Real Time Clock" an external battery (3.3V) must be connected. Connect "+" to VBAT and "-" to GND.

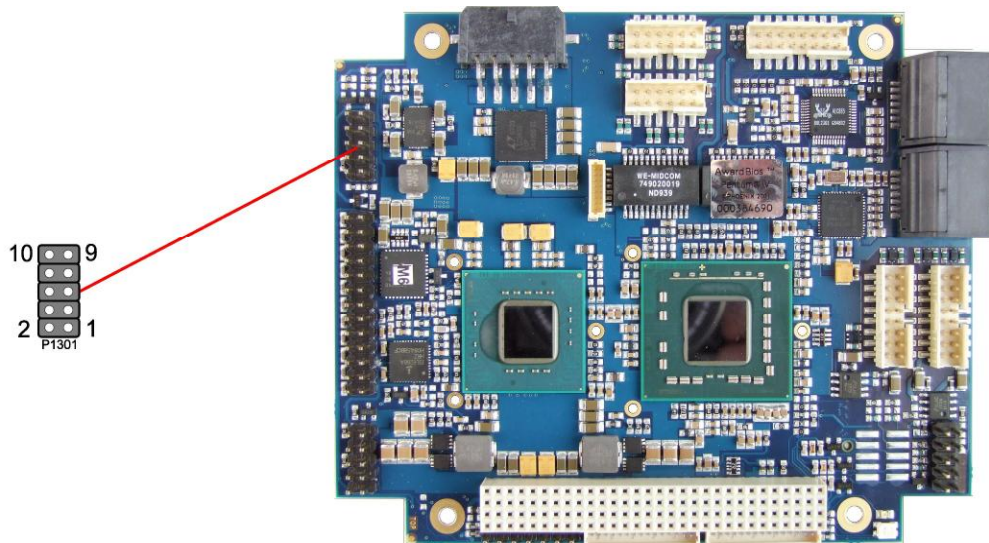

Description	Name	Pin	Name	Description	
speaker to 5 volt	SPEAKER	1	2	GND	ground
reset to ground	RESET#	3	4	KLOCK#	keyboard lock
keyboard Data	KDAT	5	6	KCLK	keyboard clock
mouse data	MDAT	7	8	MCLK	mouse clock
CMOS battery ≥ 3 volt	VBAT	9	10	VCC	5 volt supply

3.4 Memory

There is one conventional SO-DIMM204 socket available to equip the board with memory (DDR3-1066). It is located on the bottom side of the board. For technical and mechanical reasons it is possible that particular memory modules cannot be employed. Please ask your sales representative for recommended memory modules.

With currently available SO-DIMM modules a memory extension up to 4 GByte is possible. The timing parameters for different memory modules are automatically set by BIOS.

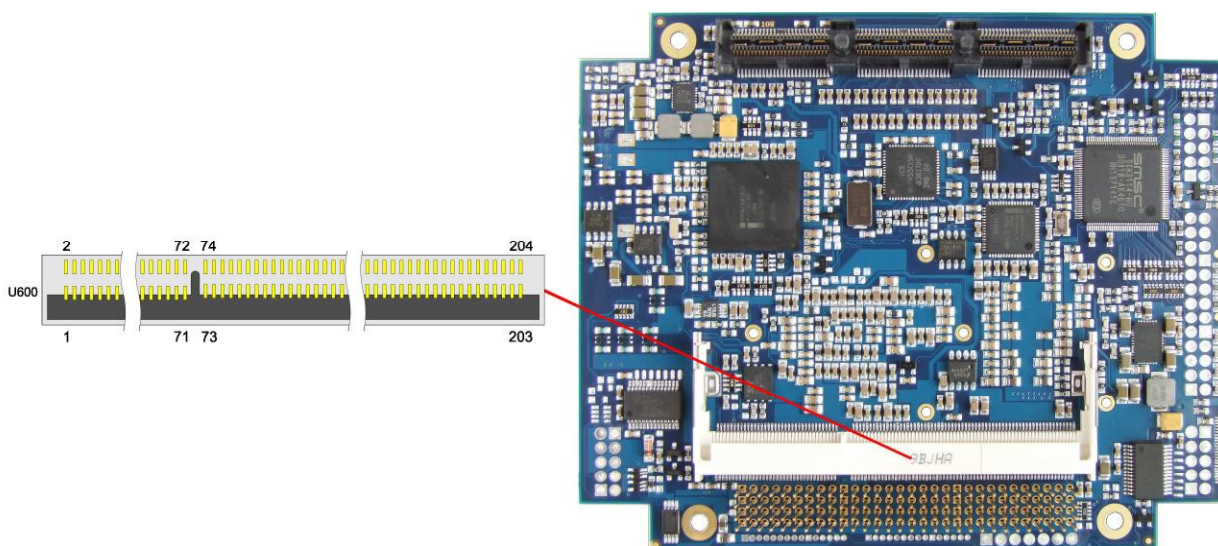

Description	Name	Pin	Name	Description
memory reference current	REF-DQ	1	2	GND
ground	GND	3	4	DQ4
data 0	DQ0	5	6	DQ5
data 1	DQ1	7	8	GND
ground	GND	9	10	DQS0#
data mask 0	DM0	11	12	DQS0
ground	GND	13	14	GND
data 2	DQ2	15	16	DQ6
data 3	DQ3	17	18	DQ7
ground	GND	19	20	GND
data 8	DQ8	21	22	DQ12
data 9	DQ9	23	24	DQ13
ground	GND	25	26	GND
data strobe 1 -	DQS1#	27	28	DM1
data strobe 1 +	DQS1	29	30	RESET#
ground	GND	31	32	GND
data 10	DQ10	33	34	DQ14
data 11	DQ11	35	36	DQ15
ground	GND	37	38	GND
data 16	DQ16	39	40	DQ20
data 17	DQ17	41	42	DQ21
ground	GND	43	44	GND
data strobe 2 -	DQS2#	45	46	DM2
data strobe 2 +	DQS2	47	48	GND
ground	GND	49	50	DQ22

Description	Name	Pin		Name	Description
data 18	DQ18	51	52	DQ23	data 23
data 19	DQ19	53	54	GND	ground
ground	GND	55	56	DQ28	data 28
data 24	DQ24	57	58	DQ29	data 29
data 25	DQ25	59	60	GND	ground
ground	GND	61	62	DQS3#	data strobe 3 -
data mask 3	DQM3	63	64	DQS3	data strobe 3 +
ground	GND	65	66	GND	ground
data 26	DQ26	67	68	DQ30	data 30
data 27	DQ27	69	70	DQ31	data 31
ground	GND	71	72	GND	ground
clock enables 0	CKE0	73	74	CKE1	clock enables 1
1.5 volt supply	1.5V	75	76	1.5V	1.5 volt supply
reserved	N/C	77	78	(A15)	reserved
SDRAM bank 2	BA2	79	80	A14	address 14
1.5 volt supply	1.5V	81	82	1.5V	1.5 volt supply
address 12 (burst chop)	A12/BC#	83	84	A11	address 11
address 9	A9	85	86	A7	address 7
1.5 volt supply	1.5V	87	88	1.5V	1.5 volt supply
address 8	A8	89	90	A6	address 6
address 5	A5	91	92	A4	address 4
1.5 volt supply	1.5V	93	94	1.5V	1.5 volt supply
address 3	A3	95	96	A2	address 2
address 1	A1	97	98	A0	address 0
1.5 volt supply	1.5V	99	100	1.5V	1.5 volt supply
Clock 0 +	CK0	101	102	CK1	clock 1 +
Clock 0 -	CK0#	103	104	CK1#	clock 1 -
1.5 volt supply	1.5V	105	106	1.5V	1.5 volt supply
address 10 (auto precharge)	A10/AP	107	108	BA1	SDRAM bank 1
SDRAM Bank 0	BA0	109	110	RAS#	row address strobe
1.5 volt supply	1.5V	111	112	1.5V	1.5 volt supply
write enable	WE#	113	114	S0#	chip select 0
column address strobe	CAS#	115	116	ODT0	on die termination 0
1.5 volt supply	1.5V	117	118	1.5V	1.5 volt supply
address 13	A13	119	120	ODT1	on die termination 1
Chip Select 1	S1#	121	122	N/C	reserved
1.5 volt supply	1.5V	123	124	1.5V	1.5 volt supply
reserved	(TEST)	125	126	REF-CA	reference current
ground	GND	127	128	GND	ground
data 32	DQ32	129	130	DQ36	data 36
data 33	DQ33	131	132	DQ37	data 37
ground	GND	133	134	GND	ground
data strobe 4 -	DQS4#	135	136	DQM4	data mask 4
data strobe 4 +	DQS4	137	138	GND	ground
ground	GND	139	140	DQ38	data 38
data 34	DQ34	141	142	DQ39	data 39
data 35	DQ35	143	144	GND	ground
ground	GND	145	146	DQ44	data 44
data 40	DQ40	147	148	DQ45	data 45
data 41	DQ41	149	150	GND	ground
ground	GND	151	152	DQS5#	data strobe 5 -
data mask 5	DQM5	153	154	DQS5	data strobe 5 +
ground	GND	155	156	GND	ground
data 42	DQ42	157	158	DQ46	data 46
data 43	DQ43	159	160	DQ47	data 47

Description	Name	Pin		Name	Description
ground	GND	161	162	GND	ground
data 48	DQ48	163	164	DQ52	data 52
data 49	DQ49	165	166	DQ53	data 53
ground	GND	167	168	GND	ground
data strobe 6 -	DQS6#	169	170	DQM6	data mask 6
data strobe 6	DQS6	171	172	GND	ground
ground	GND	173	174	DQ54	data 54
data 50	DQ50	175	176	DQ55	data 55
data 51	DQ51	177	178	GND	ground
ground	GND	179	180	DQ60	data 60
data 56	DQ56	181	182	DQ61	data 61
data 57	DQ57	183	184	GND	ground
ground	GND	185	186	DQS7#	data strobe 7 -
data mask 7	DQM7	187	188	DQS7	data strobe 7 +
ground	GND	189	190	GND	ground
data 58	DQ58	191	192	DQ62	data 62
data 59	DQ59	193	194	DQ63	data 63
ground	GND	195	196	GND	ground
SPD address 0	SA0	197	198	EVENT#	Event
3.3 volt supply	3.3V	199	200	SDA	SMBus data
SPD address 1	SA1	201	202	SCL	SMBus clock
termination current	VTT	203	204	VTT	termination current

3.5 PC/104-Plus Bus

Expansion cards can be connected to the board using the PCI connector first introduced with the PC/104-Plus standard. A maximum of four PC/104-Plus cards are supported. The interrupt routing and the IDSEL signals for the expansion cards are specified in the PC/104-Plus specification (see "Specifications and Documents", p. 12).

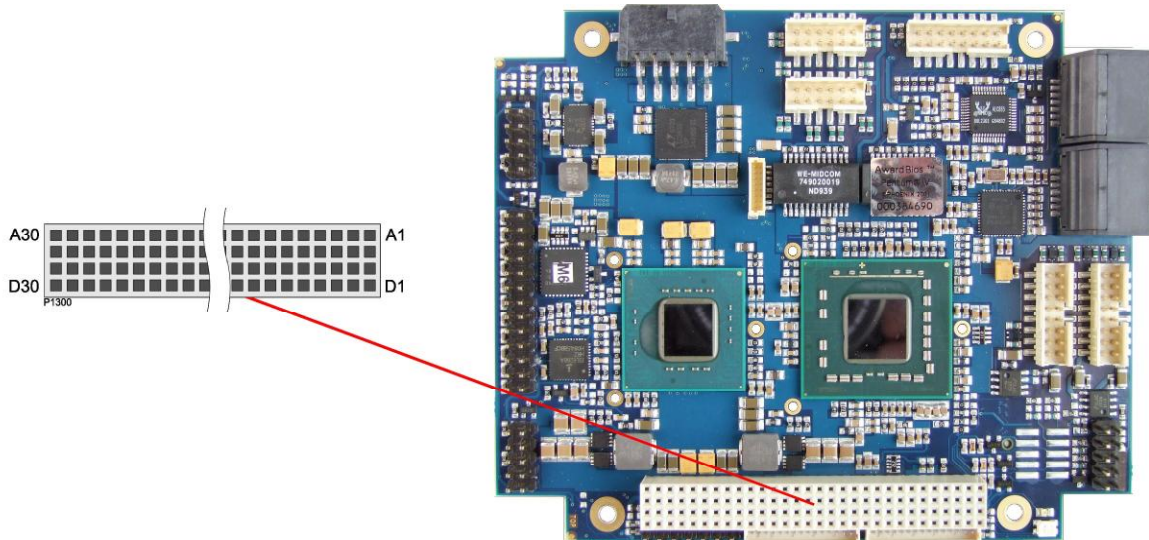

Description	Name	Pin	Name	Description
ground	GND	A1 B1	N/C	reserved
3.3 volt - IO buffer power	VIO	A2 B2	AD2	PCI – address/data 2
PCI – address/data 5	AD5	A3 B3	GND	ground
PCI – com/byte enable 0	CBE0#	A4 B4	AD7	PCI – address/data 7
ground	GND	A5 B5	AD9	PCI – address/data 9
PCI – address/data 11	AD11	A6 B6	VIO	3.3 volt - IO buffer power
PCI – address/data 14	AD14	A7 B7	AD13	PCI – address/data 13
3.3 volt supply	3.3V	A8 B8	CBE1#	PCI – com/byte enable 1
PCI – system error	SERR#	A9 B9	GND	ground
ground	GND	A10 B10	PERR#	PCI – parity error
PCI – stop	stop#	A11 B11	3.3V	3.3 volt supply
3.3 volt supply	3.3V	A12 B12	TRDY#	PCI – target ready
PCI – frame	FRAME#	A13 B13	GND	ground
ground	GND	A14 B14	AD16	PCI – address/data 16
PCI – address/data 18	AD18	A15 B15	3.3V	3.3 volt supply
PCI – address/data 21	AD21	A16 B16	AD20	PCI – address/data 20
3.3 volt supply	3.3V	A17 B17	AD23	PCI – address/data 23
PCI – ID select slot 1	IDSEL0	A18 B18	GND	ground
PCI – address/data 24	AD24	A19 B19	CBE3#	PCI – com/byte enable 3
ground	GND	A20 B20	AD26	PCI – address/data 26
PCI – address/data 29	AD29	A21 B21	VCC	5 volt supply
5 volt supply	VCC	A22 B22	AD30	PCI – address/data 30
PCI – bus request slot 1	REQ0#	A23 B23	GND	ground
ground	GND	A24 B24	REQ2#	PCI – bus request slot 3
PCI – bus grant slot 4	GNT1#	A25 B25	VIO	5 volt - IO buffer power
5 volt supply	VCC	A26 B26	CLK0	PCI – clock slot 1
PCI – clock slot 3	CLK2	A27 B27	VCC	5 volt supply

Description	Name	Pin		Name	Description
ground	GND	A28	B28	INTD#	PCI – interrupt D
12V supply	12V	A29	B29	INTA#	PCI – interrupt A
-12V supply	-12V	A30	B30	REQ3#	PCI – bus request slot 4
5 volt supply	VCC	C1	D1	AD0	PCI – address/data 0
PCI – address/data 1	AD1	C2	D2	VCC	5 volt supply
PCI – address/data 4	AD4	C3	D3	AD3	PCI – address/data 3
ground	GND	C4	D4	AD6	PCI – address/data 6
PCI – address/data 8	AD8	C5	D5	GND	ground
PCI – address/data 10	AD10	C6	D6	M66EN	PCI – 66MHz enable
ground	GND	C7	D7	AD12	PCI – address/data 12
PCI – address/data 15	AD15	C8	D8	3.3V	3.3 volt supply
reserved	N/C	C9	D9	PAR	PCI – parity bit
3.3 volt supply	3.3V	C10	D10	N/C	reserved
PCI – lock	LOCK#	C11	D11	GND	ground
ground	GND	C12	D12	DEVSEL#	PCI – device select
PCI – initiator ready	IRDY#	C13	D13	3.3V	3.3 volt supply
3.3 volt supply	3.3V	C14	D14	CBE2#	PCI – com/byte enable 2
PCI – address/data 17	AD17	C15	D15	GND	ground
ground	GND	C16	D16	AD19	PCI – address/data 19
PCI – address/data 22	AD22	C17	D17	3.3V	3.3 volt supply
PCI – ID select slot 2	IDSEL1	C18	D18	IDSEL2	PCI – ID select slot 3
3,3 volt - IO buffer power	VIO	C19	D19	IDSEL3	PCI – ID select slot 4
PCI – address/data 25	AD25	C20	D20	GND	ground
PCI – address/data 28	AD28	C21	D21	AD27	PCI – address/data 27
ground	GND	C22	D22	AD31	PCI – address/data 31
PCI – bus request slot 2	REQ1#	C23	D23	VIO	3,3 volt - IO buffer power
5 volt supply	VCC	C24	D24	GNT0#	PCI – bus grant slot 1
PCI – bus grant slot 3	GNT2#	C25	D25	GND	ground
ground	GND	C26	D26	CLK1	PCI – clock slot 2
PCI – clock slot 4	CLK3	C27	D27	GND	ground
5 volt supply	VCC	C28	D28	RST#	PCI – reset
PCI – interrupt B	INTB#	C29	D29	INTC#	PCI – interrupt C
PCI – bus grant slot 4	GNT3#	C30	D30	GND	ground

3.6 PCI/104-Express Bus

Expansion modules for the PCI-Express bus can be connected to the board using the PCI/104-Express™ connector. This is a "type 1" connector which offers full PCI-Express x16. "Stacking Error" functionality is available. For specifics, please refer to the PCI/104-Express™ documentation (rev. 2.0).

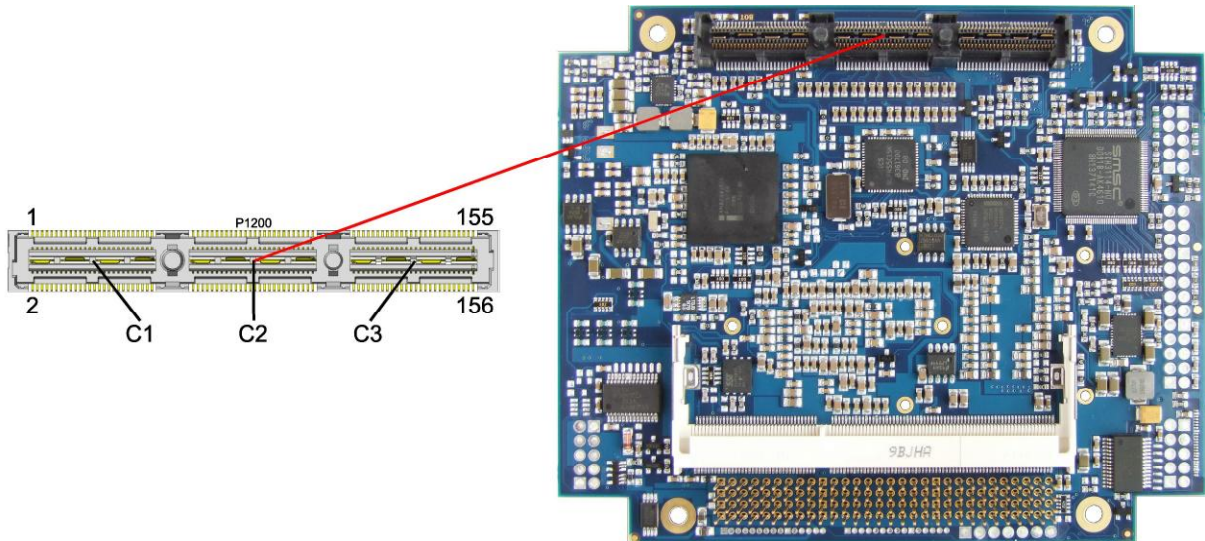

Description	Name	Pin	Name	Description	
reserved	N/C	1	2	PERST#	PCIe reset
3.3 volt supply	3.3V	3	4	3.3V	3.3 volt supply
display data channel clock	DDPC-CLK	5	6	N/C	reserved
display data channel data	DDPC-DAT	7	8	N/C	reserved
ground	GND	9	10	GND	ground
transmit lane 2 +	PET2	11	12	PET1	transmit lane 1 +
transmit lane 2 -	PET2#	13	14	PET1#	transmit lane 1 -
ground	GND	15	16	GND	ground
transmit lane 3 +	PET3	17	18	PET4	transmit lane 4 +
transmit lane 3 -	PET3#	19	20	PET4#	transmit lane 4 -
ground	GND	21	22	GND	ground
receive lane 2 +	PER2	23	24	PER1	receive lane 1 +
receive lane 2 -	PER2#	25	26	PER1#	receive lane 1 -
ground	GND	27	28	GND	ground
receive lane 3 +	PER3	29	30	PER4	receive lane 4 +
receive lane 3 -	PER3#	31	32	PER4#	receive lane 4 -
ground	GND	33	34	GND	ground
clock slot 1 +	PECLK1	35	36	PECLK0	clock slot 0 +
clock slot 1 -	PECLK1#	37	38	PECLK0#	clock slot 0 -
5 volt standby supply	SVCC	39	40	SVCC	5 volt standby supply
clock slot 2 +	PECLK2	41	42	PECLK3	clock slot 3 +
clock slot 2 -	PECLK2#	43	44	PECLK3#	clock slot 3 -
CPU direction	CPU_DIR	45	46	PWRGOOD	powergood
SMBus data	SMBDAT	47	48	PECLKx16	clock x16 slot +
SMBus clock	SMBCLK	49	50	PECLKx16#	clock x16 slot -
SMBus alert	SMBALERT	51	52	PSON#	PSU on
link reactivation	PEWAKE#	53	54	PEGENA#	PCIe graphics enable
ground	GND	55	56	GND	ground

Description	Name	Pin		Name	Description
x16 transmit lane 8 +	PE16T8	57	58	PE16T0	x16 transmit lane 0 +
x16 transmit lane 8 -	PE16T8#	59	60	PE16T0#	x16 transmit lane 0 -
ground	GND	61	62	GND	ground
x16 transmit lane 9 +	PE16T9	63	64	PE16T1	x16 transmit lane 1 +
x16 transmit lane 9 -	PE16T9#	65	66	PE16T1#	x16 transmit lane 1 -
ground	GND	67	68	GND	ground
x16 transmit lane 10 +	PE16T10	69	70	PE16T2	x16 transmit lane 2 +
x16 transmit lane 10 -	PE16T10#	71	72	PE16T2#	x16 transmit lane 2 -
ground	GND	73	74	GND	ground
x16 transmit lane 11 +	PE16T11	75	76	PE16T3	x16 transmit lane 3 +
x16 transmit lane 11 -	PE16T11#	77	78	PE16T3#	x16 transmit lane 3 -
ground	GND	79	80	GND	ground
x16 transmit lane 12 +	PE16T12	81	82	PE16T4	x16 transmit lane 4 +
x16 transmit lane 12 -	PE16T12#	83	84	PE16T4#	x16 transmit lane 4 -
ground	GND	85	86	GND	ground
x16 transmit lane 13 +	PE16T13	87	88	PE16T5	x16 transmit lane 5 +
x16 transmit lane 13 -	PE16T13#	89	90	PE16T5#	x16 transmit lane 5 -
ground	GND	91	92	GND	ground
x16 transmit lane 14 +	PE16T14	93	94	PE16T6	x16 transmit lane 6 +
x16 transmit lane 14 -	PE16T14#	95	96	PE16T6#	x16 transmit lane 6 -
ground	GND	97	98	GND	ground
x16 transmit lane 15 +	PE16T15	99	100	PE16T7	x16 transmit lane 7 +
x16 transmit lane 15 -	PE16T15#	101	102	PE16T7#	x16 transmit lane 7 -
ground	GND	103	104	GND	ground
SDVO data	SDVODAT	105	106	SDVOCLK	SDVO clock
ground	GND	107	108	GND	ground
x16 receive lane 8 +	PE16R8	109	110	PE16R0	x16 receive lane 0 +
x16 receive lane 8 -	PE16R8#	111	112	PE16R0#	x16 receive lane 0 -
ground	GND	113	114	GND	ground
x16 receive lane 9 +	PE16R9	115	116	PE16R1	x16 receive lane 1 +
x16 receive lane 9 -	PE16R9#	117	118	PE16R1#	x16 receive lane 1 -
ground	GND	119	120	GND	ground
x16 receive lane 10 +	PE16R10	121	122	PE16R2	x16 receive lane 2 +
x16 receive lane 10 -	PE16R10#	123	124	PE16R2#	x16 receive lane 2 -
ground	GND	125	126	GND	ground
x16 receive lane 11 +	PE16R11	127	128	PE16R3	x16 receive lane 3 +
x16 receive lane 11 -	PE16R11#	129	130	PE16R3#	x16 receive lane 3 -
ground	GND	131	132	GND	ground
x16 receive lane 12 +	PE16R12	133	134	PE16R4	x16 receive lane 4 +
x16 receive lane 12 -	PE16R12#	135	136	PE16R4#	x16 receive lane 4 -
ground	GND	137	138	GND	ground
x16 receive lane 13 +	PE16R13	139	140	PE16R5	x16 receive lane 5 +
x16 receive lane 13 -	PE16R13#	141	142	PE16R5#	x16 receive lane 5 -
ground	GND	143	144	GND	ground
x16 receive lane 14 +	PE16R14	145	146	PE16R6	x16 receive lane 6 +
x16 receive lane 14 -	PE16R14#	147	148	PE16R6#	x16 receive lane 6 -
ground	GND	149	150	GND	ground
x16 receive lane 15 +	PE16R15	151	152	PE16R7	x16 receive lane 7 +
x16 receive lane 15 -	PE16R15#	153	154	PE16R7#	x16 receive lane 7 -
ground	GND	155	156	GND	ground
5 volt supply	VCC	C1			
5 volt supply	VCC	C2			
12 volt supply	12V	C3			

3.7 VGA

The CRT-VGA signals are provided by a 2x5pin connector (FCI 98424-G52-10LF, mating connector e.g. FCI 90311-010LF).

This interface allows the connection of a standard VGA-monitor. I2C communication is supported.

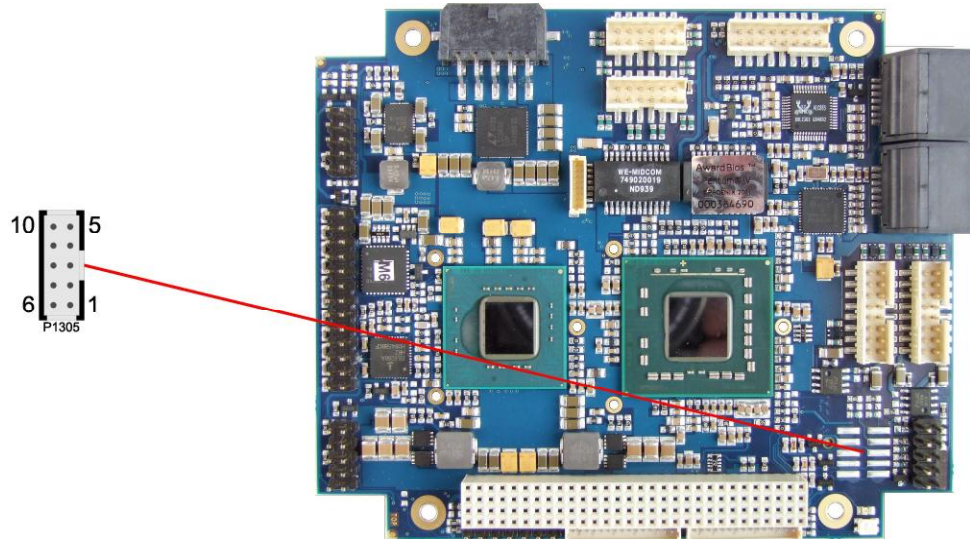

Description	Name	Pin	Name	Description
analog red	RED	1	6	GND
analog green	GREEN	2	7	DDDA
analog blue	BLUE	3	8	DDCK
vertikal sync	VSYNC	4	9	GND
horizontal sync	HSYNC	5	10	GND

3.8 LCD

The LCD is connected via two 15 pin connectors (Hirose DF13-15P-1.25DSA, mating connector: DF13-15S-xxx). The power supply for the display is also provided through these connectors. The CB4052 board only supports displays with LVDS interface. For displays with digital interface an extra receiver board is available. There is no support for DSTN displays.

With the LVDS interface it is possible to trigger LVDS displays with a maximum of 24 Bit colour depth and one or two pixels per clock. For single pixel displays only one connector is necessary. However, if you want to read the display's EDID data the second connector must be connected.

The display type can be chosen over the BIOS setup. Please contact your sales representative regarding an appropriate cable to connect your display.

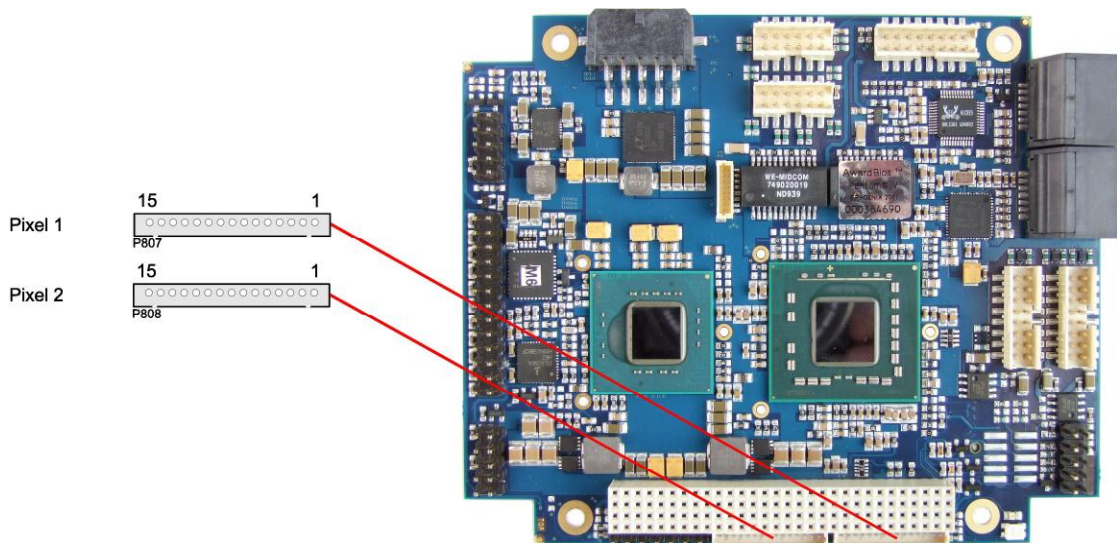

The following table shows the pin description for the first bit ("even" pixel).

Pin	Name	Description
1	GND	ground
2	GND	ground
3	TXO00#	LVDS even data 0 -
4	TXO00	LVDS even data 0 +
5	TXO01#	LVDS even data 1 -
6	TXO01	LVDS even data 1 +
7	TXO02#	LVDS even data 2 -
8	TXO02	LVDS even data 2 +
9	TXO0C#	LVDS even clock -
10	TXO0C	LVDS even clock +
11	TXO03#	LVDS even data 3 -
12	TXO03	LVDS even data 3 +
13	BL_VCC	switched 5 volt for backlight
14	FP_3.3V	switched 3.3 volt for display
15	FP_3.3V	switched 3.3 volt for display

The following table shows the pin description for the second bit ("odd" pixel). This connector will only be used if a display with two pixels per clockcycle is to be connected.

Pin	Name	Description
1	GND	ground
2	GND	ground
3	TXO10#	LVDS odd data 0 -
4	TXO10	LVDS odd data 0 +
5	TXO11#	LVDS odd data 1 -
6	TXO11	LVDS odd data 1 +
7	TXO12#	LVDS odd data 2 -
8	TXO12	LVDS odd data 2 +
9	TXO1C#	LVDS odd clock -
10	TXO1C	LVDS odd clock +
11	TXO13#	LVDS odd data 3 -
12	TXO13	LVDS odd data 3 +
13	DDC_CLK	EDID clock for LCD
14	DDC_DAT	EDID data for LCD
15	VCC	5 volt supply

3.9 USB

USB channels 1 to 8 are provided via two 2x8pin connectors (FCI 98424-G52-16LF, mating connector e.g. FCI 90311-016LF).

All USB-channels support USB 2.0. You may note that the setting of USB keyboard or USB mouse support in the BIOS-setup is only necessary and advisable, if the OS offers no USB-support. BIOS-setup can be changed with a USB keyboard without enabling USB keyboard support. Running a USB supporting OS (such as Microsoft® Windows®) with these features enabled may lead to significant performance or functionality limitations.

Every USB interface provides up to 500 mA current and is protected by an electronically resettable fuse.

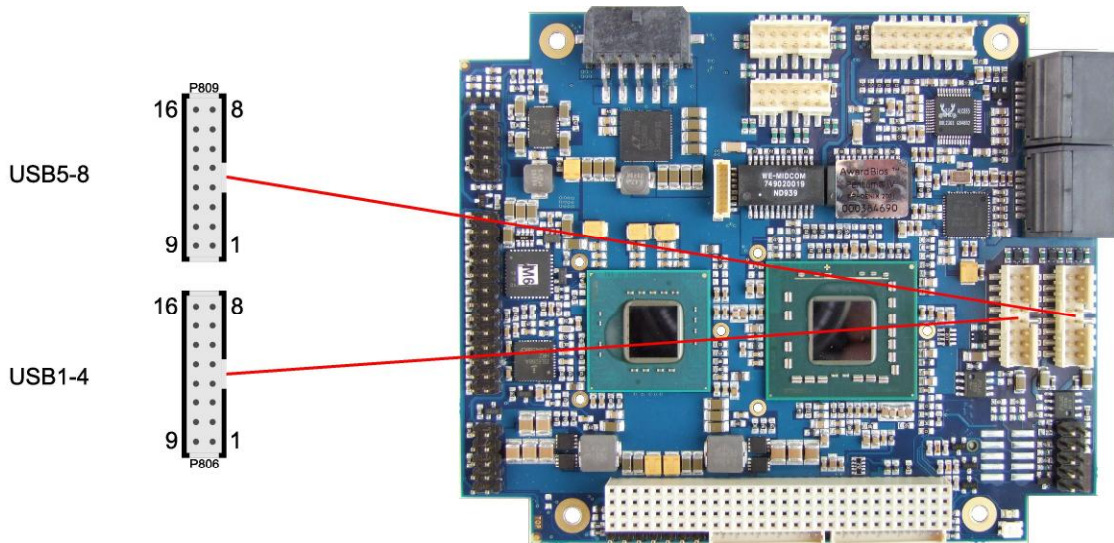

Pinout USB 1-4:

Description	Name	Pin		Name	Description
5 volt for USB1	USB1 VCC	1	9	USB2VCC	5 volt for USB2
minus channel USB1	USB1#	2	10	USB2#	minus channel USB2
plus channel USB1	USB1	3	11	USB2	plus channel USB2
ground	GND	4	12	GND	ground
ground	GND	5	13	GND	ground
plus channel USB3	USB3	6	14	USB4	plus channel USB4
minus channel USB3	USB3#	7	15	USB4#	minus channel USB4
5 volt for USB3	USB3VCC	8	16	USB4VCC	5 volt for USB4

Pinout USB 5-8:

Description	Name	Pin		Name	Description
5 volt for USB5	USB5 VCC	1	9	USB6VCC	5 volt for USB6
minus channel USB5	USB5#	2	10	USB6#	minus channel USB6
plus channel USB5	USB5	3	11	USB6	plus channel USB6
ground	GND	4	12	GND	ground
ground	GND	5	13	GND	ground
plus channel USB7	USB7	6	14	USB8	plus channel USB8
minus channel USB7	USB7#	7	15	USB8#	minus channel USB8
5 volt for USB7	USB7VCC	8	16	USB8VCC	5 volt for USB8

3.10 LAN

Both LAN interfaces are provided via a 2x6pin connector (FCI 98424-G52-12LF, mating connector e.g. FCI 90311-012LF). The interfaces support 10BaseT, 100BaseT, and 1000BaseT compatible network components with automatic bandwidth selection. Additional outputs are provided for status LEDs. Auto-negotiate and auto-cross functionality is available, PXE and RPL are available on request.

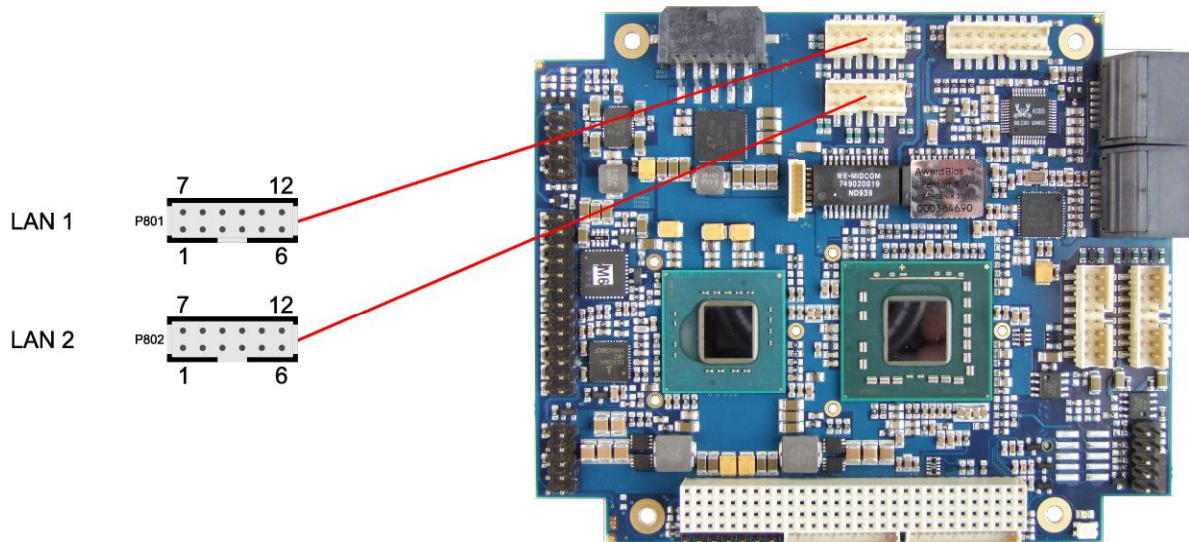

Pinout LAN interface:

Description	Name	Pin	Name	Description
LAN activity	LINKACT	1	7	SPEED1000 LAN speed 1000Mbit
LAN channel 1 plus	LAN1	2	8	LAN0 LAN channel 0 plus
LAN channel 1 minus	LAN1#	3	9	LAN0# LAN channel 0 minus
LAN channel 3 plus	LAN3	4	10	LAN2 LAN channel 2 plus
LAN channel 3 minus	LAN3#	5	11	LAN2# LAN channel 2 minus
LAN speed 100Mbit	SPEED100	6	12	3.3V 3.3 volt supply

3.11 Audio

The CB4052's audio functions are provided via a 2x8pin connector (FCI 98424-G52-16LF, mating connector e.g. FCI 90311-016LF). This interface provides eight output channels for full 7.1 sound output. Two microphone inputs and two AUX inputs are also available. The signals "SPDIFI" and "SPDIFO" provide digital input and output. If a transformation to a coaxial or optical connector is necessary this must be performed externally.

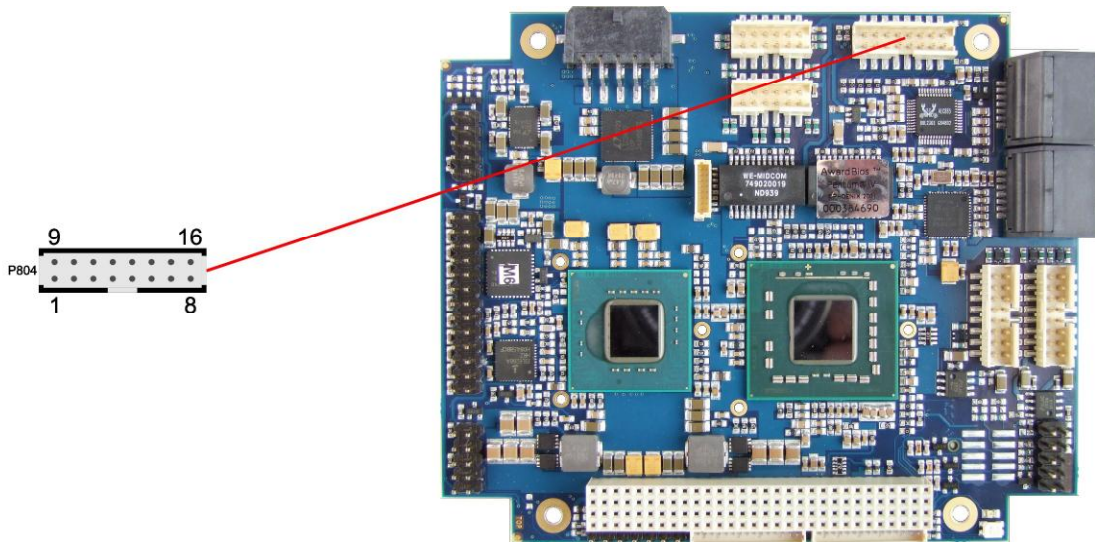

Description	Name	Pin	Name	Description	
digital output SPDIF	SPDIFO	1	9	3.3V	3.3 volt supply
digital input SPDIF	SPDIFI	2	10	S_AGND	analog ground sound
sound output right	LOUT_R	3	11	LOUT_L	sound output left
AUX input right	AUXA_R	4	12	AUXA_L	AUX input left
microphone input 1	MIC1	5	13	MIC2	microphone input 2
surround out right	SOUT_R	6	14	SOUT_L	surround out left
center output	CENOUT	7	15	LFEOUT	LFE output
side surround out right	SSOUT_R	8	16	SSOUT_L	side surround out left

3.12 SATA Interfaces

The CB4052 provides four SATA interfaces allowing transfer rates of up to 3 Gb/s. These interfaces are made available via two 7 pin connectors. RAID 0/1/5/10 is available. The required settings are made in the BIOS setup.

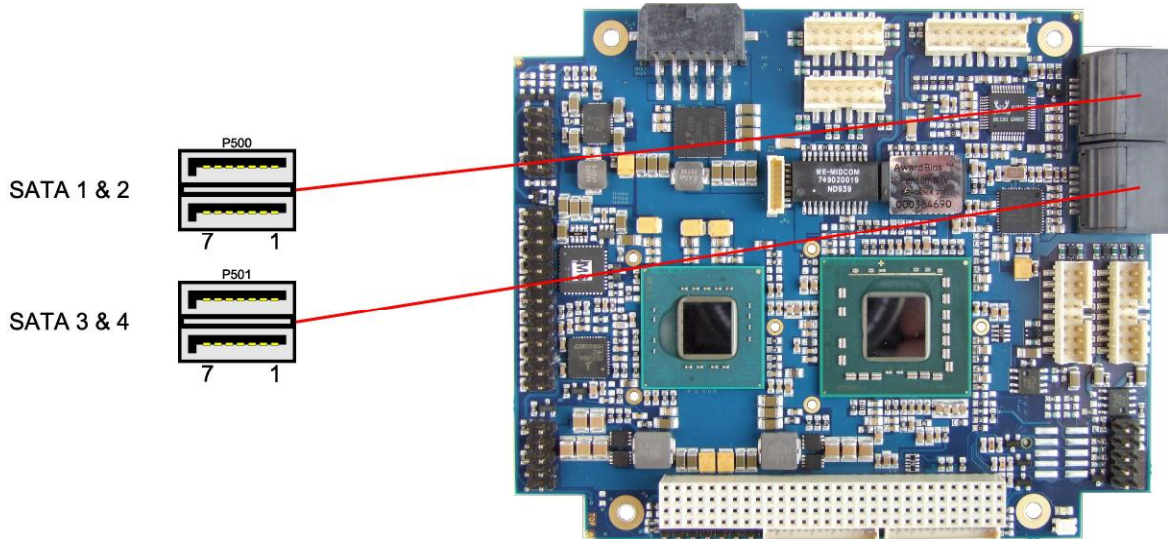

Pinout SATA:

Pin	Name	Description
1	GND	ground
2	SATATX	SATA transmit +
3	SATATX#	SATA transmit -
4	GND	ground
5	SATARX	SATA receive +
6	SATARX#	SATA receive -
7	GND	ground

3.13 Parallel Interface LPT

The parallel interface is a standard IDC socket connector with a spacing of 2.54 mm. The port address and the interrupt are set via the BIOS setup.

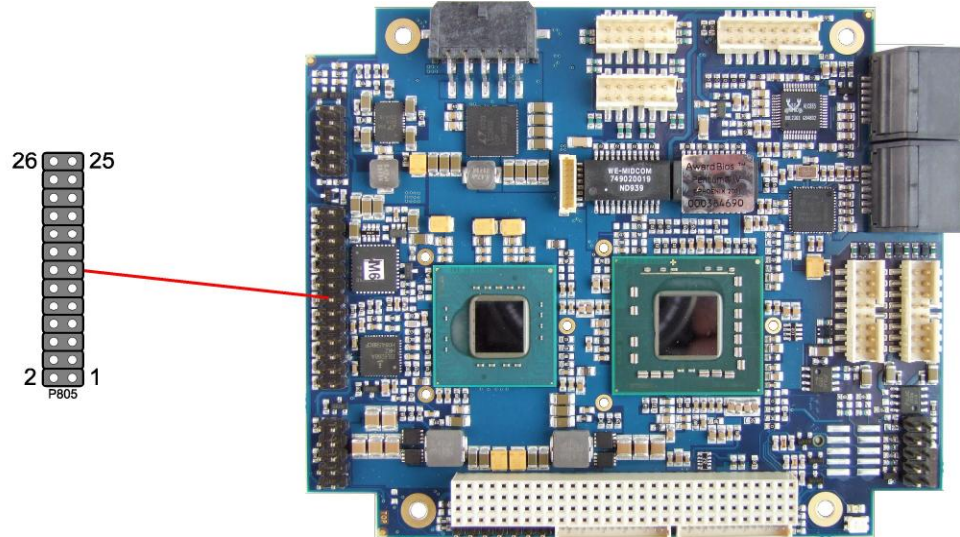

Description	Name	Pin	Name	Description	
strobe	STB#	1	2	AFD#	automatic line feed
LPT data 0	PD0	3	4	ERR#	error
LPT data 1	PD1	5	6	INIT#	init
LPT data 2	PD2	7	8	SLIN#	select input
LPT data 3	PD3	9	10	GND	ground
LPT data 4	PD4	11	12	GND	ground
LPT data 5	PD5	13	14	GND	ground
LPT data 6	PD6	15	16	GND	ground
LPT data 7	PD7	17	18	GND	ground
acknowledge	ACK#	19	20	GND	ground
busy	BUSY	21	22	GND	ground
paper end	PE	23	24	GND	ground
select printer	SLCT	25	26	VCC	5 volt supply

3.14 Serial Interface COM1

The serial interface is a standard IDC socket connector with a spacing of 2.54 mm. Signals default to RS-232 but can also be ordered as RS-422 or RS-485. The port address and the interrupt are set via the BIOS setup.

 **CAUTION**

COM 1 & 2 cables are not the same pin orientation and you may damage the COM interface and CPU attached if you use the incorrect COM cable.

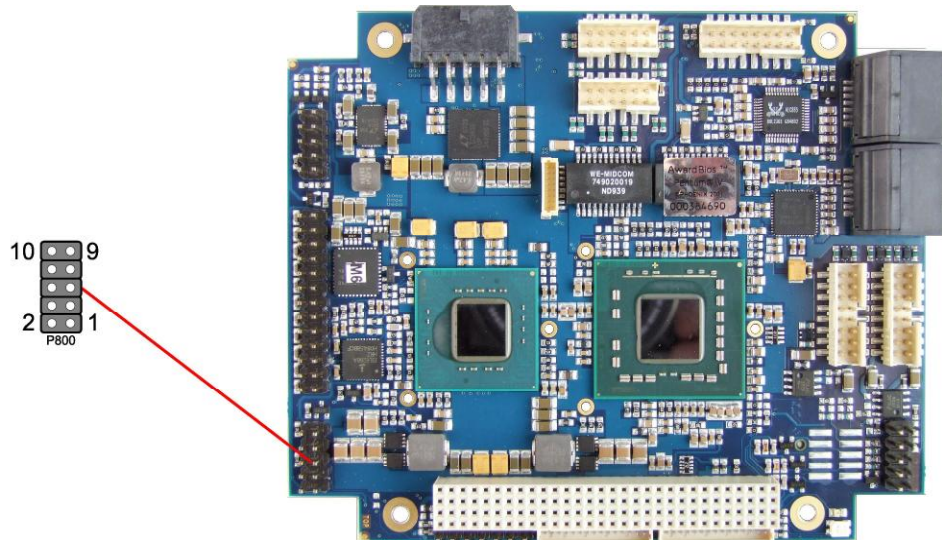

Description	Name	Pin	Name	Description	
data carrier detect	DCD	1	2	DSR	data set ready
receive data	RXD	3	4	RTS	request to send
transmit data	TXD	5	6	CTS	clear to send
data terminal ready	DTR	7	8	RI	ring indicator
ground	GND	9	10	VCC	5 volt supply

Pinout with RS422/485 soldering option:

Description	Name	Pin	Name	Description	
transmit data +	TX	1	2	TX#	transmit data -
receive data +	RX	3	4	RX#	receive data -
reserved	N/C	5	6	N/C	reserved
reserved	N/C	7	8	N/C	reserved
ground	GND	9	10	VCC	5 volt supply

3.15 Serial Interface COM2

The serial interface is a standard IDC socket connector with a spacing of 2.54 mm. Signals default to RS-232 but can also be ordered as RS-422 or RS-485. The port address and the interrupt are set via the BIOS setup.



CAUTION

COM 1 & 2 cables are not the same pin orientation and you may damage the COM interface and CPU attached if you use the incorrect COM cable.

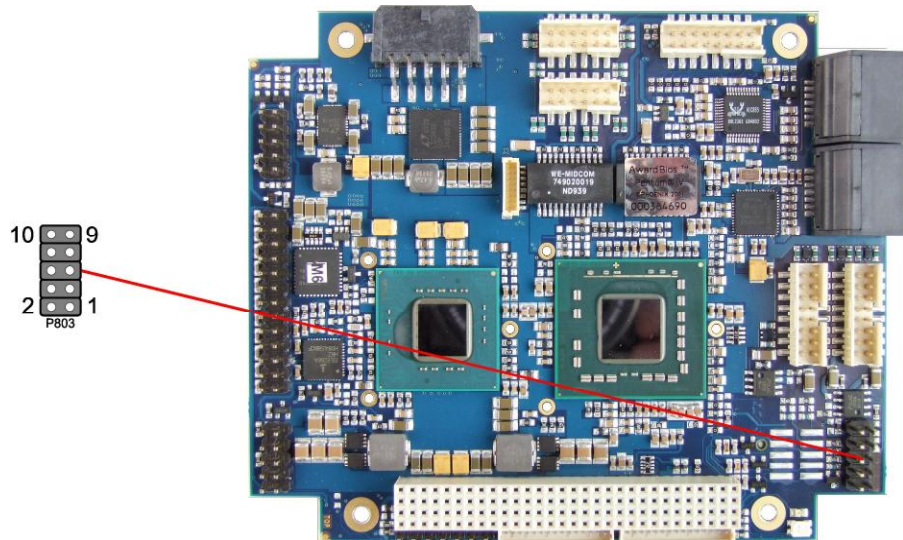

Description	Name	Pin	Pin	Name	Description
data carrier detect	DCD	1	2	DSR	data set ready
receive data	RXD	3	4	RTS	request to send
transmit data	TXD	5	6	CTS	clear to send
data terminal ready	DTR	7	8	RI	ring indicator
ground	GND	9	10	VCC	5 volt supply

Pinout with RS422/485 soldering option:

Description	Name	Pin	Pin	Name	Description
transmit data +	TX	1	2	TX#	transmit data -
receive data +	RX	3	4	RX#	receive data -
reserved	N/C	5	6	N/C	reserved
reserved	N/C	7	8	N/C	reserved
ground	GND	9	10	VCC	5 volt supply

3.16 SMBus

The CB4052 can communicate with external devices via the SMBus protocol. The signals for this protocol are available through a standard IDC socket connector with a spacing of 2.54 mm. A 3.3 volt power supply is also available for these SMBus devices. Additionally, you can use this connector to access the PWRBTN# and PS_ON# signals used for power control. If PWRBTN# is held low for four seconds an unconditional hardware power-down event will occur. In the off state S5 both SMBALRT# and PWRBTN# will generate a power-on event if asserted.

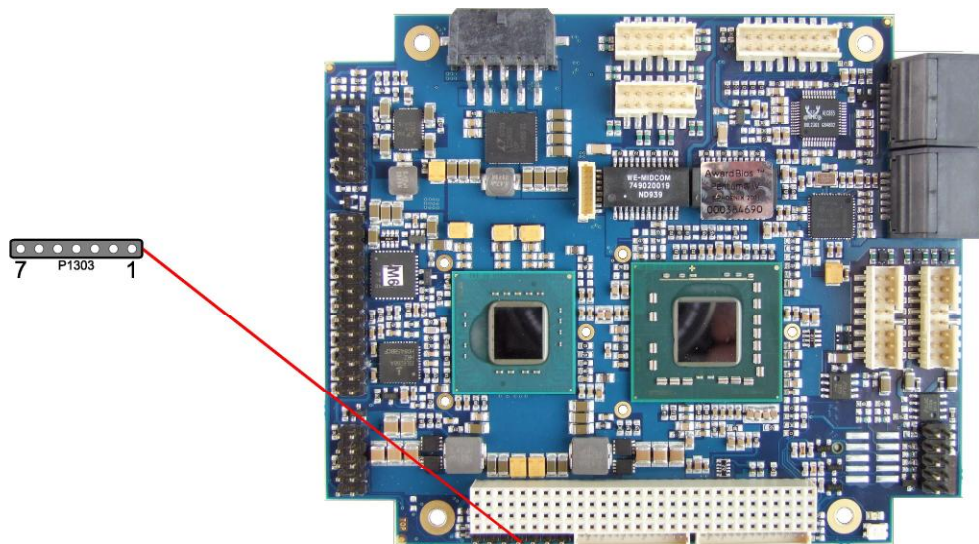

Pin	Name	Description
1	3.3V	3.3 volt supply
2	CS-SMB-CLK	SMBus clock
3	CS-SMB-DAT	SMBus data
4	SMB-ALERT#	SMBus alert
5	PWRBTN#	power button
6	PS_ON#	power supply on
7	GND	ground

3.17 Monitoring Functions

Additional monitoring functions, such as the status of the fan or of other devices connected over SM-Bus (e. g. temperature sensor), are accessible via an 8 pin connector (JST BM08B-SRSS-TB, mating connector: SHR-08V-S(-B)).

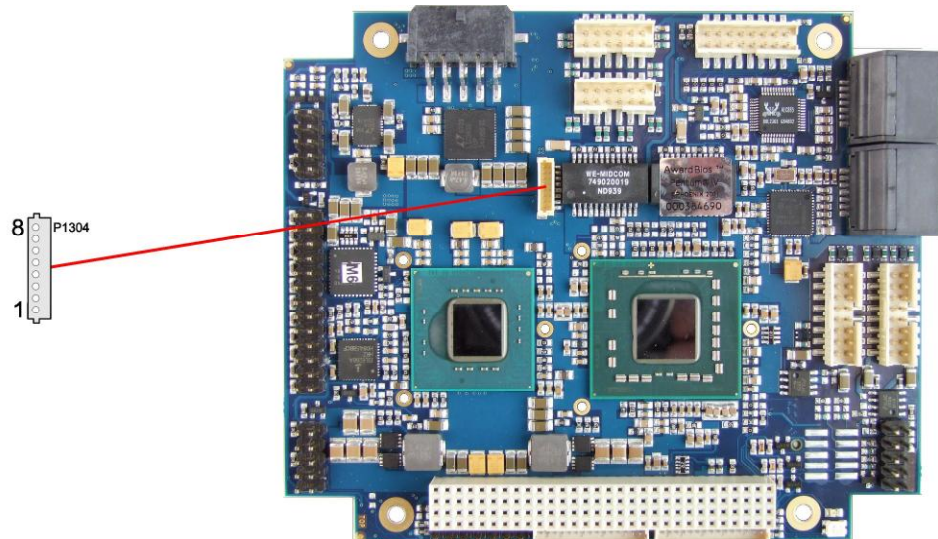

Pin	Name	Description
1	3.3V	3.3 volt supply
2	CS-SMB-CLK	SMBus clock
3	CS-SMB-DAT	SMBus data
4	GND	ground
5	FANON1	5 volt supply (switched)
6	FANCTRL1	fan 1 monitoring signal
7	VCC	5 volt supply
8	FANCTRL3	fan 3 monitoring signal

4 Status LEDs

4.1 HD LED

Harddisk activity is signalled by a dedicated LED.

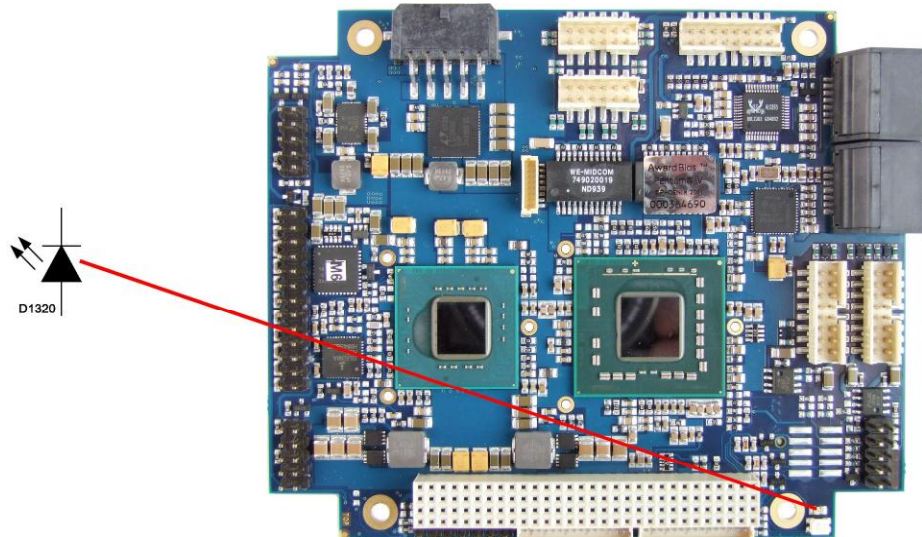

4.2 RGB LED

The CB4052 has an RGB LED, which can signal status messages by using different colors and flash intervals.

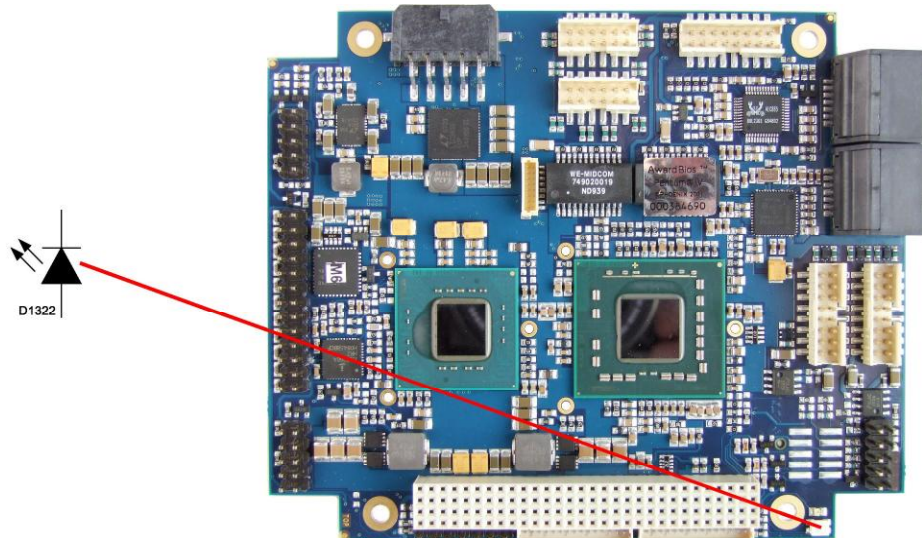

Status Codes RGB LED:

Color	Interval	Meaning
none	solid	Invalid system state
White	solid	The microcontroller has just been flashed and is being prepared for normal operation after reboot
Cyan	solid	Reserved
Magenta	solid	Reserved
Blue	solid	Reserved
Yellow	solid	Reserved
Green	solid	Board operates normal
Red	solid	Board is in Reset
Green/Yellow	flashing	Bootloader operates normal
Red	flashing	Firmware is being started (start sequence still running)
Red/Yellow	flashing	Bootloader is being started (start sequence still running)
Red/Magenta	flashing	Checksum error during I2C transmission in bootloader
Red/Blue	flashing	Update completed, waiting for manual Reset
Yellow	flashing (10s)	S5 state
Yellow	flashing (6s)	S4 state
Yellow	flashing (3s)	Reserved
Yellow	flashing (0.5s)	Reserved



NOTE

If the board appears to be in Reset (Red LED lit) then this could also indicate a PCI104-Express "stacking error". Such an error could occur when the stack contains a peripheral card which has the wrong type of connector (PCI104-Express Type 1 instead of Type 2 or vice versa).

5 BIOS Settings

5.1 Remarks for Setup Use

In a setup page, standard values for its setup entries can be loaded. Fail-safe defaults are loaded with F6 and optimized defaults are loaded with F7. These standard values are independent of the fact that a board has successfully booted with a setup setting before.

This is different if these defaults are called from the Top Menu. Once a setup setting was saved, which subsequently leads to a successful boot process, those values are loaded as default for all setup items afterwards.

See also the chapters "Load Fail-Safe Defaults" (5.10) and "Load Optimized Defaults" (5.11).



NOTE

BIOS features and setup options are subject to change without notice. The settings displayed in the screenshots on the following pages are meant to be examples only. They do not represent the recommended settings or the default settings. Determination of the appropriate settings is dependent upon the particular application scenario in which the board is used.

5.2 Top Level Menu

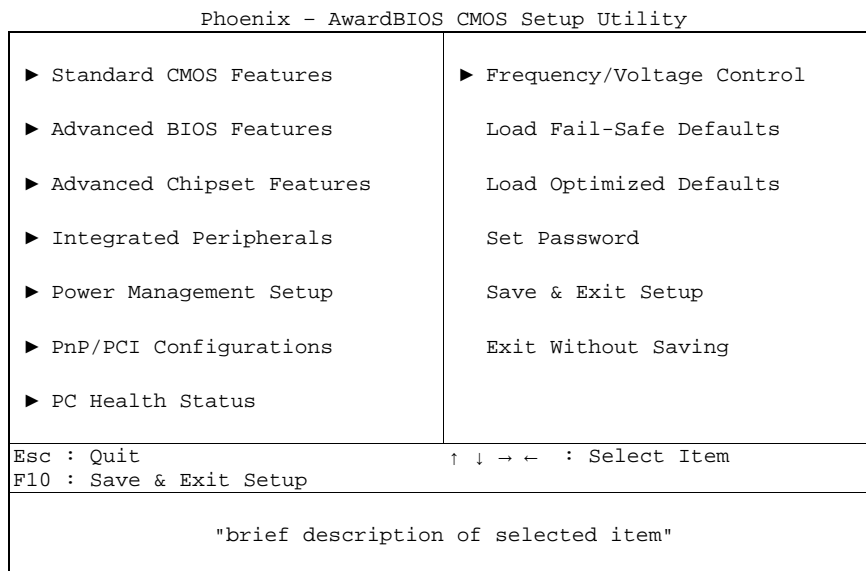

The sign „▶“ in front of an item means that there is a sub menu.

The „x“ sign in front of an item means, that the item is disabled but can be enabled by changing or selecting some other item (usually somewhere above the disabled item on the same screen).

Use the arrow buttons to navigate from one item to another. For selecting an item press Enter which will open either a sub menu or a dialog screen.

5.3 Standard CMOS Features

Phoenix - AwardBIOS CMOS Setup Utility
Standard CMOS Features

Date (mm:dd:yy)	Thu, Jan 25 2010	Item Help
Time (hh:mm:ss)	11 : 13 : 35	
▶ IDE Channel 0 Master	[None]	
▶ IDE Channel 1 Master	[None]	
Base Memory	640K	
Extended Memory	2086912K	
Total Memory	2087936K	

↑↓←→:Move Enter:Select +/-/PU/PD:Value F10:Save ESC:Exit F1:Help
F5: Previous Values F6: Fail-Safe Defaults F7: Optimized Defaults

ü Date (mm:dd:yy)

Options: mm: month
dd: day
yy: year

ü Time (hh:mm:ss)

Options: hh: hours
mm: minutes
ss: seconds

ü IDE Channel 0 Master

Sub menu: see "IDE Channel 0 Master/Slave" (p. 40)

ü IDE Channel 1 Master

Sub menu: see "IDE Channel 0 Master/Slave" (p. 40)

ü Base Memory

Options: none

ü Extended Memory

Options: none

ü Total Memory

Options: none

5.3.1 IDE Channel 0 Master/Slave

Phoenix - AwardBIOS CMOS Setup Utility
IDE Channel 0 Master

IDE HDD Auto-Detection	[Press Enter]	Item Help
IDE Channel 0 Master	[Auto]	
Access Mode	[Auto]	
Capacity	0 MB	
Cylinder	0	
Head	0	
Precomp	0	
Landing Zone	0	
Sector	0	

↑↓←→:Move Enter:Select +/-/PU/PD:Value F10:Save ESC:Exit F1:Help
F5: Previous Values F6: Fail-Safe Defaults F7: Optimized Defaults

ü IDE HDD Auto-Detection

Options: none

ü IDE Channel 0 Master

Options: None / Auto / Manual

ü Access Mode

Options: CHS / LBA / Large / Auto

ü Capacity

Options: none

ü Cylinder

Options: none

ü Head

Options: none

ü Precomp

Options: none

ü Landing Zone

Options: none

ü Sector

Options: none

5.4 Advanced BIOS Features

Phoenix - AwardBIOS CMOS Setup Utility
Advanced BIOS Features

		Item Help
▶ CPU Feature	[Press Enter]	
▶ Hard Disk Boot Priority	[Press Enter]	
CPU L3 Cache	[Enabled]	
Quick Power On Self Test	[Enabled]	
First Boot Device	[Hard Disk]	
Second Boot Device	[Hard Disk]	
Third Boot Device	[Disabled]	
Boot Other Device	[Enabled]	
Boot Up NumLock Status	[On]	
Gate A20 Option	[Fast]	
Typematic Rate Setting	[Disabled]	
x Typematic Rate (Chars/Sec)	6	
x Typematic Delay (Msec)	250	
Security Option	[Setup]	
APIC Mode	[Enabled]	
MPS Version Control For OS	[1.4]	
OS Select For DRAM > 64MB	[Non OS2]	
Full Screen LOGO Show	[Disabled]	
Summary Screen Show	[Enabled]	

↑↓←→:Move Enter:Select +/-/PU/PD:Value F10:Save ESC:Exit F1:Help
F5: Previous Values F6: Fail-Safe Defaults F7: Optimized Defaults

ü CPU Feature

Sub menu: see "CPU Feature" (p. 43)

ü Hard Disk Boot Priority

Sub menu: see "Hard Disk Boot Priority" (p. 44)

ü CPU L3 Cache

Options: Enabled / Disabled

ü Quick Power On Self Test

Options: Enabled / Disabled

ü First Boot Device

Options: LS120 / Hard Disk / CDROM / ZIP100 / USB-FDD / USB-ZIP / Legacy LAN / Disabled

ü Second Boot Device

Options: LS120 / Hard Disk / CDROM / ZIP100 / USB-FDD / USB-ZIP / Legacy LAN / Disabled

ü Third Boot Device

Options: LS120 / Hard Disk / CDROM / ZIP100 / USB-FDD / USB-ZIP / Legacy LAN / Disabled

ü Boot Other Device

Options: Enabled / Disabled

ü Boot Up NumLock Status

Options: Off / On

ü Gate A20 Option

Options: Normal / Fast

ü Typematic Rate Setting

Options: Enabled / Disabled

ü Typematic Rate (Chars/Sec)

Options: 6 / 8 / 10 / 12 / 15 / 20 / 24 / 30

- ü **Typematic Delay (Msec)**
Options: 250 / 500 / 750 / 1000
- ü **Security Option**
Options: Setup / System
- ü **APIC Mode**
Options: Enabled / Disabled
- ü **MPS Version Control For OS**
Options: 1.1 / 1.4
- ü **OS Select For DRAM > 64MB**
Options: Non-OS2 / OS2
- ü **Full Screen LOGO Show**
Options: Enabled / Disabled
- ü **Summary Screen Show**
Options: Enabled / Disabled

5.4.1 CPU Feature

Phoenix - AwardBIOS CMOS Setup Utility

CPU Feature

C1E Function	[Auto]	Item Help
CPU C State Capability	[Disable]	
Execute Disable Bit	[Enabled]	
Core Multi-Processing	[Enabled]	

↑↓←→:Move Enter:Select +/-/PU/PD:Value F10:Save ESC:Exit F1:Help
 F5: Previous Values F6: Fail-Safe Defaults F7: Optimized Defaults

- ü **C1E Function**
Options: Auto / Disabled

- ü **CPU C State Capability**
Options: Disable / C2 / C4 / Deep C4

- ü **Execute Disable Bit**
Options: Enabled / Disabled

- ü **Core Multi-Processing**
Options: Enabled / Disabled

5.4.2 Hard Disk Boot Priority

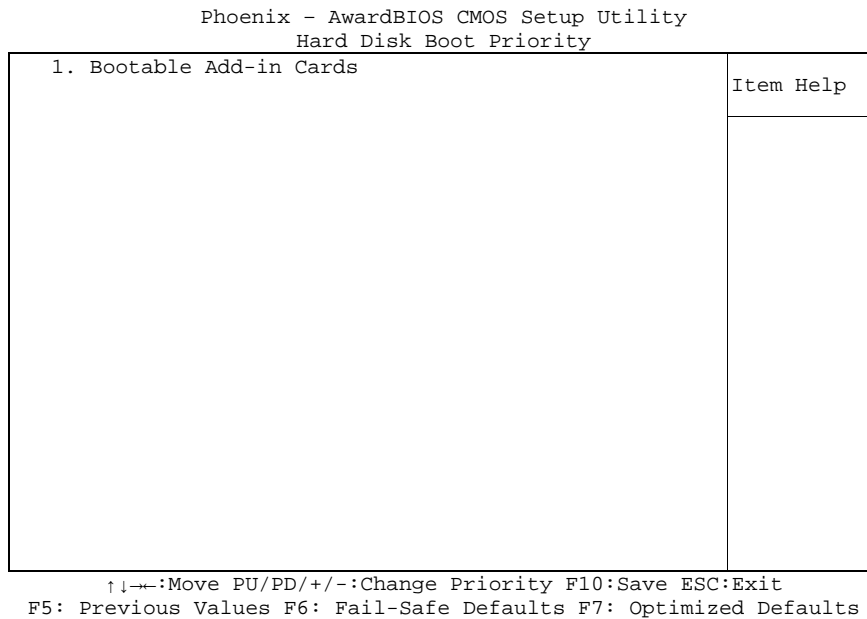

ü [list of available devices]

Options: this dialog allows you to set the order in which the available bootable devices shall be accessed for an attempt to boot.

ü Attention!

in this sub menu the buttons <Page Up>, <Page Down>, <+> and <-> have a different function than in the rest of the setup: They serve to move the items of the list up or down.

5.5 Advanced Chipset Features

Phoenix - AwardBIOS CMOS Setup Utility
Advanced Chipset Features

System BIOS Cacheable	[Enabled]	Item Help
Memory Hole At 15M-16M	[Disabled]	
Support FSB and DDR3 667Mh	Disabled	
▶ PCI Express Root Port Func	[Press Enter]	
VT-d	[Disabled]	
** VGA Setting **		
PEG/Onchip VGA Control	[Auto]	
PEG Force x1	[Disabled]	
On-Chip Frame Buffer Size	[64MB]	
DVMT Mode	[Enable]	
Total GFX Memory	[128MB]	
PAVP Mode	[PAVP-Lite]	
** VGA Boot Device Setting **		
Boot Display	[VBIOS Default]	

↑↓←→:Move Enter:Select +/-/PU/PD:Value F10:Save ESC:Exit F1:Help
F5: Previous Values F6: Fail-Safe Defaults F7: Optimized Defaults

- ü **System BIOS Cacheable**
Options: Enabled / Disabled
- ü **Memory Hole At 15M-16M**
Options: Enabled / Disabled
- ü **Support FSB and DDR3 667Mhz**
Options: none
- ü **PCI Express Root Port Func**
Sub menu: see "PCI Express Root Port Function" (p. 46)
- ü **VT-d**
Options: Enabled / Disabled
- ü **PEG/Onchip VGA Control**
Options: Onchip VGA / PEG Port / Auto
- ü **PEG Force X1**
Options: Enabled / Disabled
- ü **On-Chip Frame Buffer Size**
Options: 32MB / 64MB / 128MB
- ü **DVMT Mode**
Options: Disable / Enable
- ü **Total GFX Memory**
Options: 128MB / 256MB / MAX.
- ü **PAVP Mode**
Options: Disable / PAVP-Lite / PAVP-High
- ü **Boot Display**
Options: VBIOS Default / CRT / DVI / HDMI / CRT+DVI

5.5.1 PCI Express Root Port Function

Phoenix - AwardBIOS CMOS Setup Utility
PCI Express Root Port Func

PCI Express Port 1	[Auto]	Item Help
PCI Express Port 2	[Auto]	
PCI Express Port 3	[Auto]	
PCI Express Port 4	[Auto]	
PCI Express Port 5	[Auto]	
PCI Express Port 6	[Auto]	
PCI-E Compliancy Mode	[v1.0a]	

↑↓←→:Move Enter:Select +/-/PU/PD:Value F10:Save ESC:Exit F1:Help
F5: Previous Values F6: Fail-Safe Defaults F7: Optimized Defaults

- ü **PCI Express Port 1**
Options: Auto / Enabled / Disabled
- ü **PCI Express Port 2**
Options: Auto / Enabled / Disabled
- ü **PCI Express Port 3**
Options: Auto / Enabled / Disabled
- ü **PCI Express Port 4**
Options: Auto / Enabled / Disabled
- ü **PCI Express Port 5**
Options: Auto / Enabled / Disabled
- ü **PCI Express Port 6**
Options: Auto / Enabled / Disabled
- ü **PCI-E Compliancy Mode**
Options: v1.0a / v1.0

5.6 Integrated Peripherals

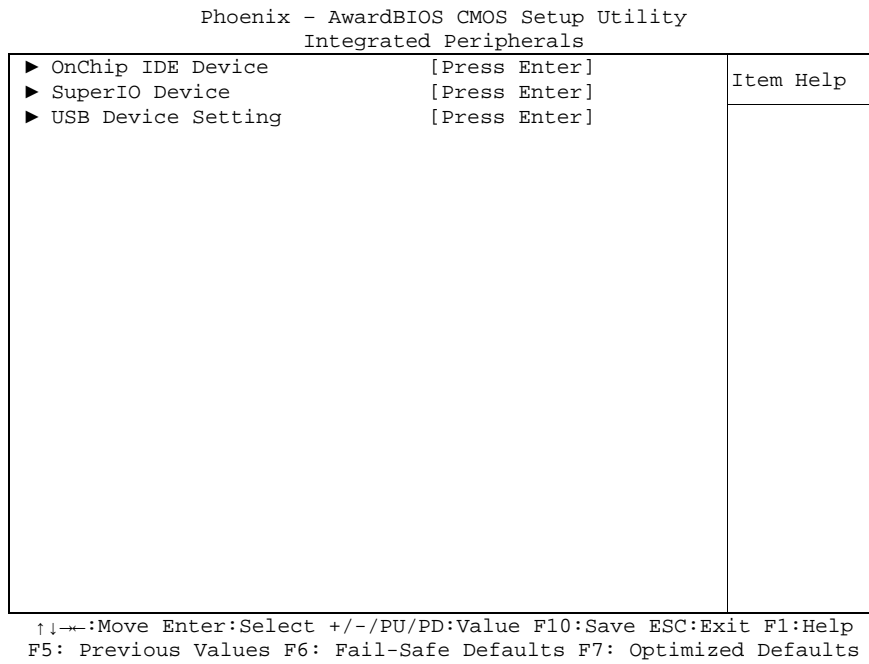

- ü **OnChip IDE Device**
Sub menu: see "OnChip IDE Devices" (p. 48)
- ü **SuperIO Device**
Sub menu: see "SuperIO Devices" (p. 50)
- ü **USB Device Setting**
Sub menu: see "USB Device Setting" (p. 51)

5.6.1 OnChip IDE Devices

Phoenix - AwardBIOS CMOS Setup Utility
OnChip IDE Device

IDE HDD Block Mode	[Enabled]	Item Help
IDE DMA transfer access	[Enabled]	
IDE Primary Master PIO	[Auto]	
IDE Primary Slave PIO	[Auto]	
IDE Primary Master UDMA	[Auto]	
IDE Primary Slave UDMA	[Auto]	
On-Chip Secondary PCI IDE	[Enabled]	
IDE Secondary Master PIO	[Auto]	
IDE Secondary Slave PIO	[Auto]	
IDE Secondary Master UDMA	[Auto]	
IDE Secondary Slave UDMA	[Auto]	
SATA Mode	[IDE]	
LEGACY Mode Support	[Disabled]	

↑↓←→:Move Enter:Select +/-/PU/PD:Value F10:Save ESC:Exit F1:Help
F5: Previous Values F6: Fail-Safe Defaults F7: Optimized Defaults

ü IDE HDD Block Mode

Options: Enabled / Disabled

ü IDE DMA transfer access

Options: Enabled / Disabled

ü IDE Primary Master PIO

Options: Auto / Mode 0 / Mode 1 / Mode 2 / Mode 3 / Mode 4

ü IDE Primary Slave PIO

Options: Auto / Mode 0 / Mode 1 / Mode 2 / Mode 3 / Mode 4

ü IDE Primary Master UDMA

Options: Disabled / Auto

ü IDE Primary Slave UDMA

Options: Disabled / Auto

ü On-Chip Secondary PCI IDE

Options: Enabled / Disabled

ü IDE Secondary Master PIO

Options: Auto / Mode 0 / Mode 1 / Mode 2 / Mode 3 / Mode 4

ü IDE Secondary Slave PIO

Options: Auto / Mode 0 / Mode 1 / Mode 2 / Mode 3 / Mode 4

ü IDE Secondary Master UDMA

Options: Disabled / Auto

ü IDE Secondary Slave UDMA

Options: Disabled / Auto

ü **SATA Mode**

Options: IDE / RAID / AHCI

ü **LEGACY Mode Support**

Options: Enabled / Disabled

5.6.2 SuperIO Devices

Phoenix - AwardBIOS CMOS Setup Utility
SuperIO Device

Onboard Serial Port 1	[3F8/IRQ4]	Item Help
Onboard Serial Port 2	[2F8/IRQ3]	
Onboard Serial Port 3	[3E8/IRQ4]	
Onboard Serial Port 4	[2E8/IRQ3]	

↑↓←→:Move Enter:Select +/-/PU/PD:Value F10:Save ESC:Exit F1:Help
F5: Previous Values F6: Fail-Safe Defaults F7: Optimized Defaults

ü Onboard Serial Port 1

Options: Disabled / 3F8/IRQ4 / 2F8/IRQ3 / 3E8/IRQ4 / 2E8/IRQ3

ü Onboard Serial Port 2

Options: Disabled / 3F8/IRQ4 / 2F8/IRQ3 / 3E8/IRQ4 / 2E8/IRQ3

ü Onboard Serial Port 3

Options: Disabled / 3F8/IRQ4 / 2F8/IRQ3 / 3E8/IRQ4 / 2E8/IRQ3

ü Onboard Serial Port 4

Options: Disabled / 3F8/IRQ4 / 2F8/IRQ3 / 3E8/IRQ4 / 2E8/IRQ3

5.6.3 USB Device Setting

Phoenix - AwardBIOS CMOS Setup Utility
USB Device Setting

USB 1.0 Controller	[Enabled]	Item Help
USB 2.0 Controller	[Enabled]	
USB Operation Mode	[High Speed]	
USB Keyboard Function	[Enabled]	
USB Mouse Function	[Enabled]	
USB Storage Function	[Enabled]	
*** USB Mass Storage Device Boot Setting ***		
↑↓←→:Move Enter:Select +/-/PU/PD:Value F10:Save ESC:Exit F1:Help F5: Previous Values F6: Fail-Safe Defaults F7: Optimized Defaults		

ü USB 1.0 Controller

Options: Enabled / Disabled

ü USB 2.0 Controller

Options: Enabled / Disabled

ü USB Operation Mode

Options: Full/Low Speed / High Speed

ü USB Keyboard Function

Options: Enabled / Disabled

ü USB Mouse Function

Options: Enabled / Disabled

ü USB Storage Function

Options: Enabled / Disabled

5.7 Power Management Setup

Phoenix - AwardBIOS CMOS Setup Utility
Power Management Setup

		Item Help
▶ PCI Express PM Function	[Press Enter]	
ACPI Function	[Enabled]	
ACPI Suspend Type	[S1(POS)]	
Run VGABIOS if S3 Resume	Auto	
Power Management	[User Define]	
Video Off Method	[DPMS]	
Video Off in Suspend	[Yes]	
Suspend Type	[Stop Grant]	
Modem Use IRQ	[3]	
Suspend Mode	[Disabled]	
HDD Power Down	[Disabled]	
Soft-Off by PWR-BTTN	[Instant-Off]	
Wake-Up by PCI card	[Disabled]	
Power On by Ring	[Disabled]	
x USB KB Wake-Up From S3	Disabled	
Resume by Alarm	[Disabled]	
x Date(of Month) Alarm	0	
x Time(hh:mm:ss)	0 : 0 : 0	
** Reload Global Timer Events **		
Primary IDE 0	[Disabled]	
Primary IDE 1	[Disabled]	
Secondary IDE 0	[Disabled]	
Secondary IDE 1	[Disabled]	
FDD,COM,LPT Port	[Disabled]	
PCI PIRQ[A-D]#	[Disabled]	
HPET Support	[Enabled]	
HPET Mode	[32-bit mode]	
▶ Intel DTS Feature	[Press Enter]	

↑↓←→:Move Enter:Select +/-/PU/PD:Value F10:Save ESC:Exit F1:Help
F5: Previous Values F6: Fail-Safe Defaults F7: Optimized Defaults

ü PCI Express PM Function

Sub menu: see "PCI Express PM Function" (p. 54)

ü ACPI function

Options: Enabled / Disabled

ü ACPI Suspend Type

Options: S1(POS) / S3(STR) / S1&S3

ü Run VGABIOS if S3 Resume

Options: Auto / Yes / No

ü Power Management

Options: User Define / Min Saving / Max Saving

ü Video Off Method

Options: Blank Screen / V/H SYNC+Blank / DPMS

ü Video Off In Suspend

Options: No / Yes

ü Suspend Type

Options: Stop Grant / PwrOn Suspend

ü MODEM Use IRQ

Options: NA / 3 / 4 / 5 / 7 / 9 / 10 / 11

ü Suspend Mode

Options: Disabled / 1 Min / 2 Min / 4 Min / 8 Min / 12 Min / 20 Min / 30 Min / 40 Min / 1 Hour

- ü **HDD Power Down**
Options: Disabled / 1 Min ... 15 Min
- ü **Soft-Off by PWR-BTTN**
Options: Instant-Off / Delay 4 Sec
- ü **Wake Up by PCI Card**
Options: Enabled / Disabled
- ü **Power-On by Ring**
Options: Enabled / Disabled
- ü **USB KB Wake Up From S3**
Options: Enabled / Disabled
- ü **Resume by Alarm**
Options: Enabled / Disabled
- ü **Date(of Month) Alarm**
Options: 1 / ... / 31
- ü **Time (hh:mm:ss) Alarm**
Options: insert [hh], [mm] and [ss]
- ü **Primary IDE 0**
Options: Enabled / Disabled
- ü **Primary IDE 1**
Options: Enabled / Disabled
- ü **Secondary IDE 0**
Options: Enabled / Disabled
- ü **Secondary IDE 1**
Options: Enabled / Disabled
- ü **FDD,COM,LPT Port**
Options: Enabled / Disabled
- ü **PCI PIRQ[A-D]#**
Options: Enabled / Disabled
- ü **HPET Support**
Options: Enabled / Disabled
- ü **HPET Mode**
Options: 32-bit mode / 64-bit mode
- ü **Intel DTS Feature**
Sub menu: see "Intel DTS Feature" (p. 55)

5.7.1 PCI Express PM Function

Phoenix - AwardBIOS CMOS Setup Utility
PCI Express PM Function

PEG Port ASPM	[Disabled]	Item Help
Root Port ASPM	[Disabled]	
DMI Port ASPM	[Disabled]	

↑↓←→:Move Enter:Select +/-/PU/PD:Value F10:Save ESC:Exit F1:Help
F5: Previous Values F6: Fail-Safe Defaults F7: Optimized Defaults

ü PEG Port ASPM

Options: Disabled / L0s / L1/L0s

ü Root Port ASPM

Options: Disabled / L0s / L1 / L1/L0s

ü DMI Port ASPM

Options: Enabled / Disabled

5.7.2 Intel DTS Feature

Phoenix - AwardBIOS CMOS Setup Utility
Intel DTS Feature

Intel DTS Feature	[Enabled]	Item Help
DTS Active temperature	[55°C]	
Passive Cooling Trip Point	[95°C]	
Passive TC1 Value	[2]	
Passive TC2 Value	[0]	
Passive TSP Value	[10]	
Critical Trip Point	[POR]	

↑↓←→:Move Enter:Select +/-/PU/PD:Value F10:Save ESC:Exit F1:Help
F5: Previous Values F6: Fail-Safe Defaults F7: Optimized Defaults

ü Intel DTS Function

Options: Enabled / Disabled

ü DTS Active temperature

Options: 15°C / 23°C / 31°C / 39°C / 47°C / 55°C / 63°C / 71°C / 79°C / 87°C / 95°C / 103°C / 111°C / 119°C

ü Passive Cooling Trip Point

Options: 15°C / 23°C / 31°C / 39°C / 47°C / 55°C / 63°C / 71°C / 79°C / 87°C / 95°C / 103°C / 111°C / 119°C

ü Passive TC1 Value

Options: 0 / 1 / ... / 14 / 15

ü Passive TC2 Value

Options: 0 / 1 / ... / 14 / 15

ü Passive TSP Value

Options: 0 / 1 / ... / 14 / 15

ü Critical Trip Point

Options: POR / 15°C / 23°C / 31°C / 39°C / 47°C / 55°C / 63°C / 71°C / 79°C / 87°C / 95°C / 103°C / 111°C / 119°C / 127°C

5.8 PnP/PCI Configuration

Phoenix - AwardBIOS CMOS Setup Utility
PNP/PCI Configurations

Init Display First	[PCI Slot]	Item Help
Reset Configuration Data	[Disabled]	
Resources Controlled By	[Manual]	
▶ IRQ Resources	[Press Enter]	
PCI/VGA Palette Snoop	[Disabled]	
INT Pin 1 Assignment	[Auto]	
INT Pin 2 Assignment	[Auto]	
INT Pin 3 Assignment	[Auto]	
INT Pin 4 Assignment	[Auto]	
INT Pin 5 Assignment	[Auto]	
INT Pin 6 Assignment	[Auto]	
INT Pin 7 Assignment	[Auto]	
INT Pin 8 Assignment	[Auto]	
** PCI Express relative Maximum Payload Size	items ** [128]	

↑↓←→:Move Enter:Select +/-/PU/PD:Value F10:Save ESC:Exit F1:Help
F5: Previous Values F6: Fail-Safe Defaults F7: Optimized Defaults

ü Init Display First

Options: PCI Slot / Onboard

ü Reset Configuration Data

Options: Enabled / Disabled

ü Resources Controlled By

Options: Auto(ESCD) / Manual

ü IRQ Resources

Sub menu: see "IRQ Resources" (p. 58)

ü PCI/VGA Palette Snoop

Options: Enabled / Disabled

ü INT Pin 1 Assignment

Options: Auto / 3 / 4 / 5 / 7 / 9 / 10 / 11 / 12 / 14 / 15

ü INT Pin 2 Assignment

Options: Auto / 3 / 4 / 5 / 7 / 9 / 10 / 11 / 12 / 14 / 15

ü INT Pin 3 Assignment

Options: Auto / 3 / 4 / 5 / 7 / 9 / 10 / 11 / 12 / 14 / 15

ü INT Pin 4 Assignment

Options: Auto / 3 / 4 / 5 / 7 / 9 / 10 / 11 / 12 / 14 / 15

ü INT Pin 5 Assignment

Options: Auto / 3 / 4 / 5 / 7 / 9 / 10 / 11 / 12 / 14 / 15

ü INT Pin 6 Assignment

Options: Auto / 3 / 4 / 5 / 7 / 9 / 10 / 11 / 12 / 14 / 15

ü INT Pin 7 Assignment

Options: Auto / 3 / 4 / 5 / 7 / 9 / 10 / 11 / 12 / 14 / 15

ü **INT Pin 8 Assignment**

Options: Auto / 3 / 4 / 5 / 7 / 9 / 10 / 11 / 12 / 14 / 15

ü **Maximum Payload Size**

Options: none

5.8.1 IRQ Resources

Phoenix - AwardBIOS CMOS Setup Utility
IRQ Resources

IRQ-3 assigned to	[PCI Device]	Item Help
IRQ-4 assigned to	[PCI Device]	
IRQ-5 assigned to	[PCI Device]	
IRQ-7 assigned to	[PCI Device]	
IRQ-9 assigned to	[PCI Device]	
IRQ-10 assigned to	[PCI Device]	
IRQ-11 assigned to	[PCI Device]	
IRQ-12 assigned to	[PCI Device]	
IRQ-14 assigned to	[PCI Device]	
IRQ-15 assigned to	[PCI Device]	

↑↓←→:Move Enter:Select +/-/PU/PD:Value F10:Save ESC:Exit F1:Help
F5: Previous Values F6: Fail-Safe Defaults F7: Optimized Defaults

- ü **IRQ-3 assigned to**
Options: PCI Device / Reserved
- ü **IRQ-4 assigned to**
Options: PCI Device / Reserved
- ü **IRQ-5 assigned to**
Options: PCI Device / Reserved
- ü **IRQ-7 assigned to**
Options: PCI Device / Reserved
- ü **IRQ-9 assigned to**
Options: PCI Device / Reserved
- ü **IRQ-10 assigned to**
Options: PCI Device / Reserved
- ü **IRQ-11 assigned to**
Options: PCI Device / Reserved
- ü **IRQ-12 assigned to**
Options: PCI Device / Reserved
- ü **IRQ-14 assigned to**
Options: PCI Device / Reserved
- ü **IRQ-15 assigned to**
Options: PCI Device / Reserved

5.9 PC Health Status

Phoenix - AwardBIOS CMOS Setup Utility
PC Health Status

Shutdown Temperature	[Disabled]	Item Help
Current CPU Temperature	50°C	
Current Board Temperature	38°C	
Current Chip Temperature	34°C	
VCC Core	0.92V	
+1.05V	1.04V	
+5 V	5.15V	
+12 V	12.22V	
Fan1 Speed	0 RPM	
Fan2 Speed	0 RPM	
Board Revision	1	

↑↓←→:Move Enter:Select +/-/PU/PD:Value F10:Save ESC:Exit F1:Help
F5: Previous Values F6: Fail-Safe Defaults F7: Optimized Defaults

ü **Shutdown Temperature**

Options: 60°C/140°F / 65°C/149°F / 70°C/158°C / Disabled

ü **Current CPU Temperature**

Options: none

ü **Current Board Temperature**

Options: none

ü **Current Chip Temperature**

Options: none

ü **VCC Core**

Options: none

ü **+1.05 V**

Options: none

ü **+5 V**

Options: none

ü **+12 V**

Options: none

ü **Fan1 Speed**

Options: none

ü **Fan2 Speed**

Options: none

ü **Board Revision**

Options: none

5.10 Frequency/Voltage Control

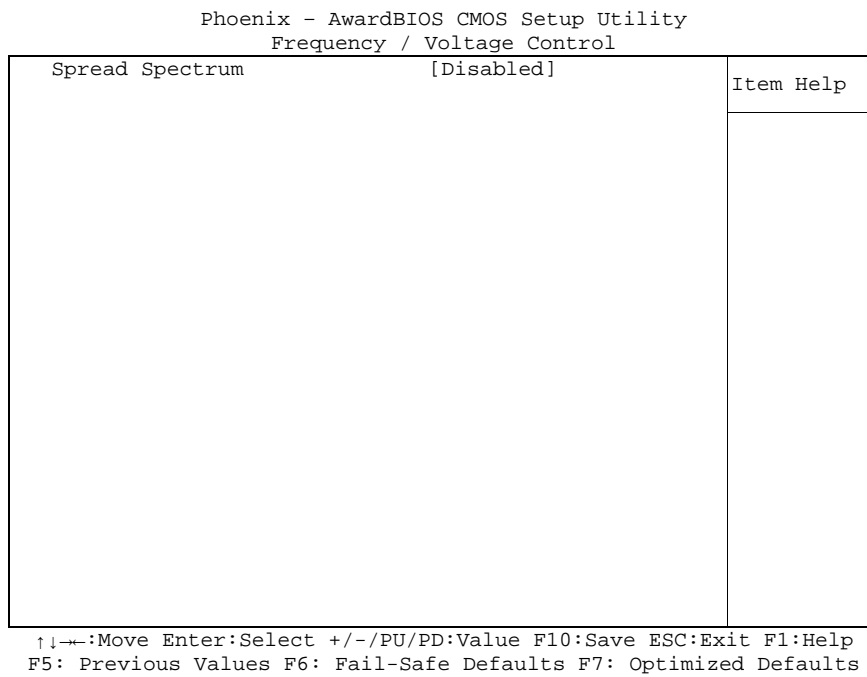

ü Spread Spectrum

Options: Enabled / Disabled

5.11 Load Fail-Safe Defaults

If this option is chosen, the last working setup is loaded from flash. Working means that the setup setting has already led to a successful boot process.

At the first setting of the BIOS setup, safe values are loaded which lets the board boot. This status is reached again, if the board is reprogrammed with the corresponding flash-program and the required parameters.

5.12 Load Optimized Defaults

This option applies like described under "Remarks for Setup Use" (5.1).

At first start of the BIOS, optimized values are loaded from the setup, which are supposed to make the board boot. This status is achieved again, if the board is reprogrammed using the flash program with the required parameters.

5.13 Set Password

Here you can enter a password to protect the BIOS settings against unauthorized changes. Use this option with care! Forgotten or lost passwords are a frequent problem.

5.14 Save & Exit Setup

Settings are saved and the board is restarted.

5.15 Exit Without Saving

This option leaves the setup without saving any changes.

6 BIOS update

If a BIOS update becomes necessary, the program "AWDFLASH.EXE" from Phoenix Technologies is used for this. It is important, that the program is started from a DOS environment without a virtual memory manager such as for example "EMM386.EXE". In case such a memory manager is loaded, the program will stop with an error message.

The system must not be interrupted during the flash process, otherwise the update is stopped and the BIOS is destroyed afterwards.

The program should be started as follows:

```
awdflash [biosfilename] /sn /cc /cp
```

/sn	Do not save the current BIOS
/cc	Clear the CMOS
/cp	Clear the PnP information

The erasure of CMOS and PnP is strongly recommended. This ensures, that the new BIOS works correctly and that all chipset registers, which were saved in the setup, are reinitialized through the BIOS. DMI should only be erased (option /cd) if the BIOS supplier advises to do so.

A complete description of all valid parameters is shown with the parameter "/?".

In order to make the updating process run automatically, the parameter "/py" must be added. This parameter bypasses all security checks during programming.



CAUTION

Updating the BIOS in an improper way can render the board unusable. Therefore, you should only update the BIOS if you really need the changes/corrections which come with the new BIOS version.



CAUTION

Before you proceed to update the BIOS you need to make absolutely sure that you have the right BIOS file which was issued for the exact board and exact board revision that you wish to update. If you try to update the BIOS using the wrong file the board will not start up again.

7 Mechanical Drawing

7.1 PCB: Mounting Holes

A true dimensioned drawing can be found in the PC/104 specification.

i **NOTE**

All dimensions are in mil (1 mil = 0,0254 mm)

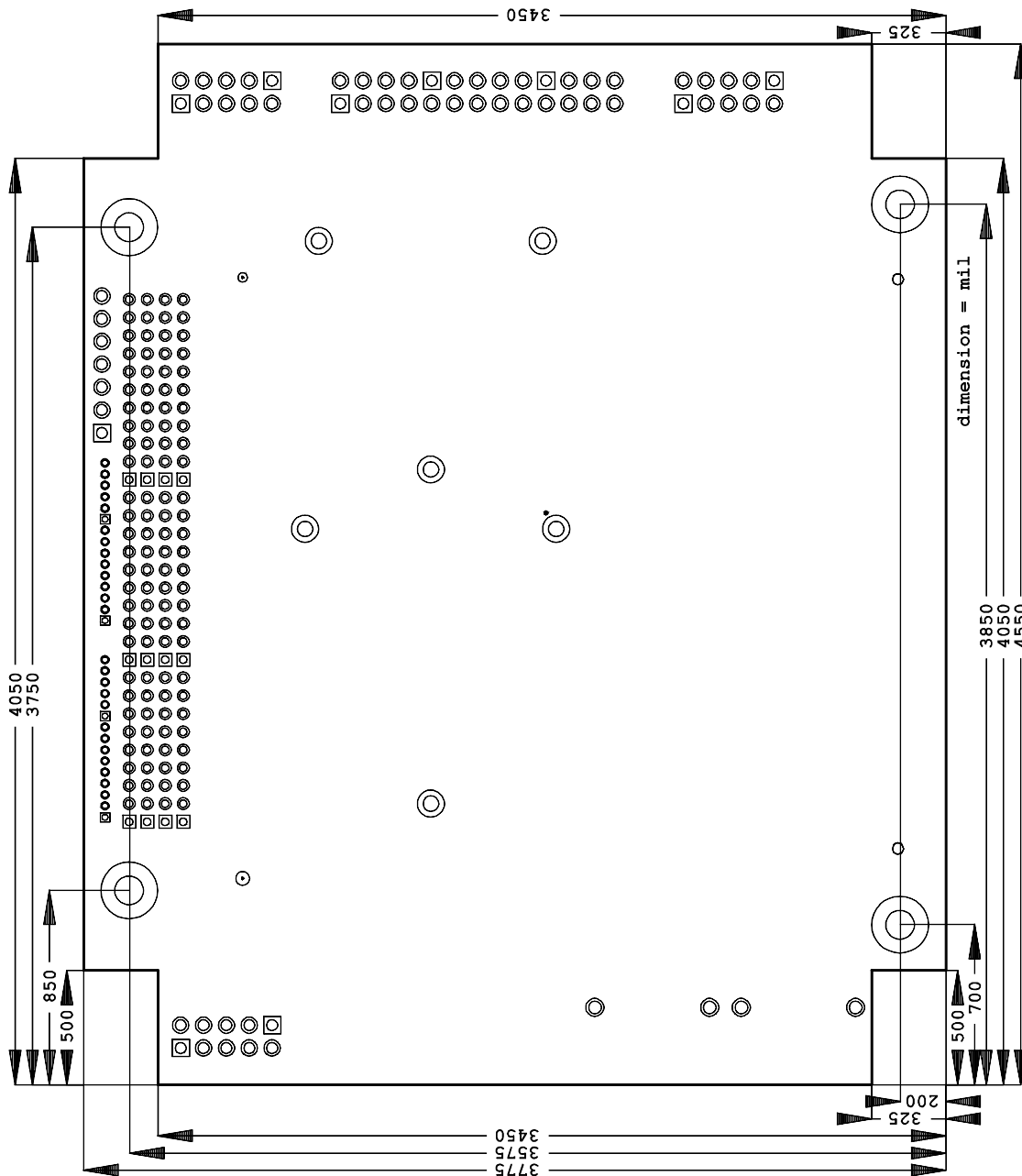

7.2 PCB: Pin 1 Dimensions



All dimensions are in mil (1 mil = 0,0254 mm)

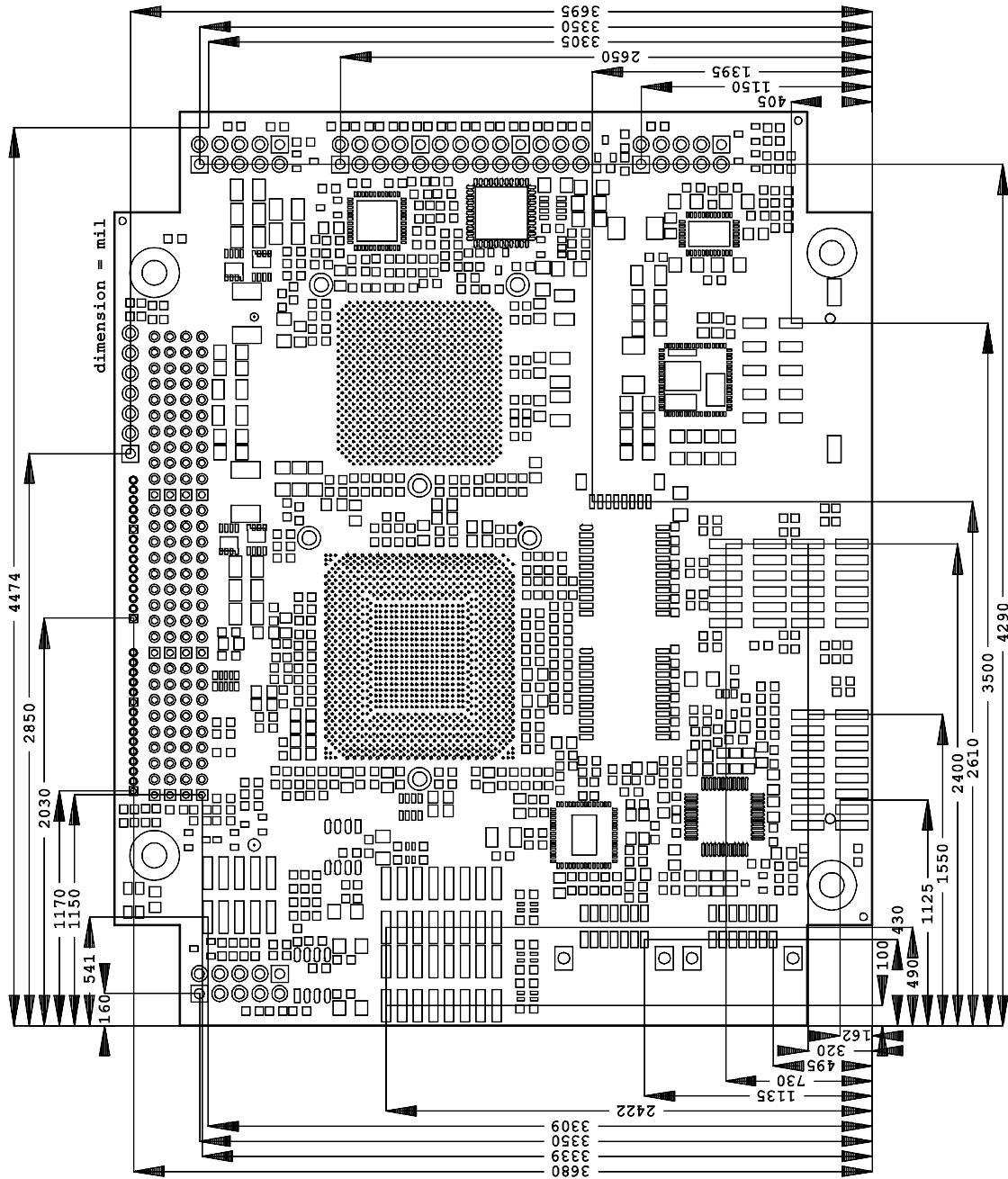

7.3 PCB: Heat Sink

i **NOTE**

All dimensions are in mil (1 mil = 0,0254 mm)

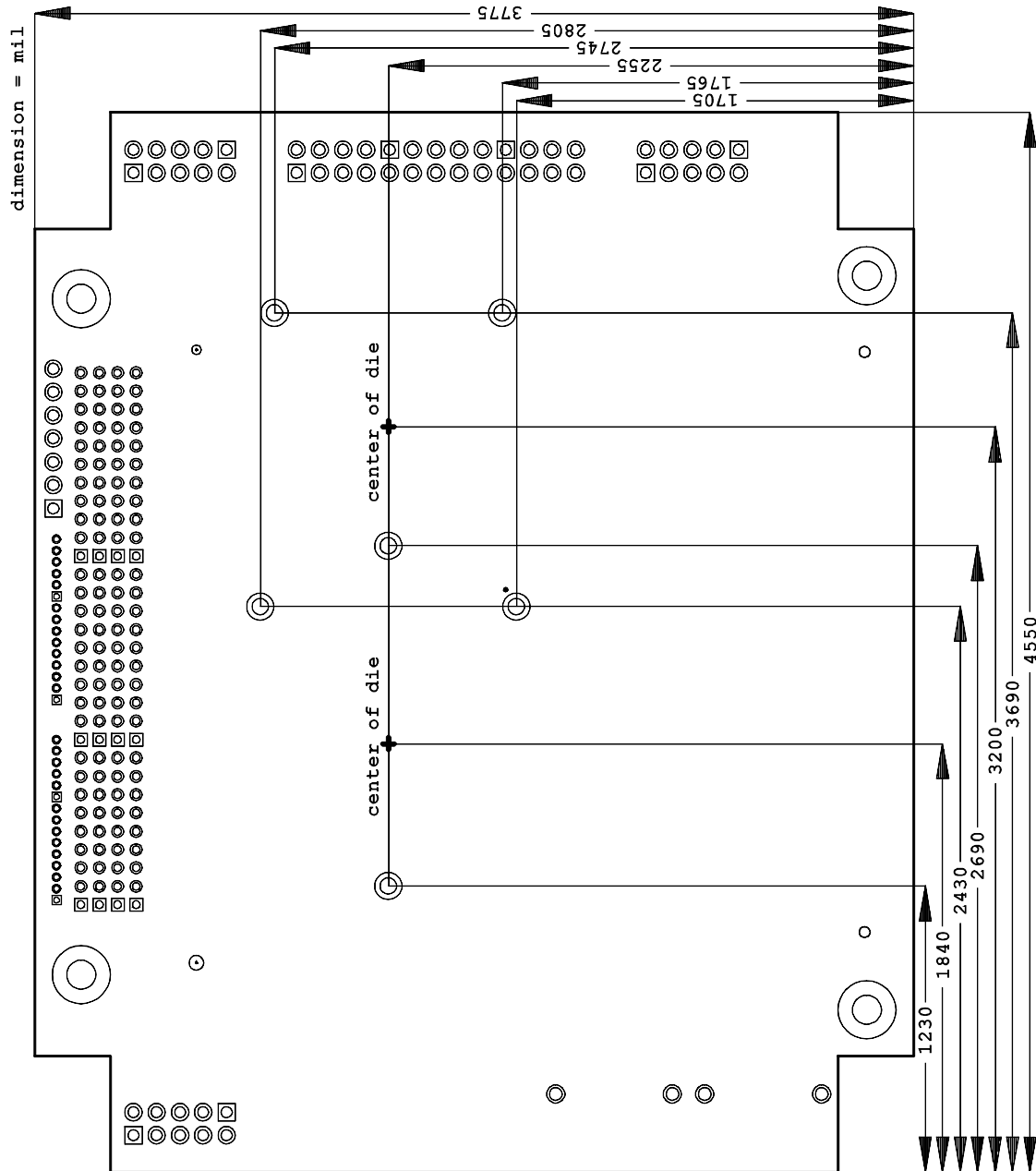

8 Technical Data

8.1 Electrical Data

Power Supply:

Board:	5 Volt and 12 Volt (+/- 5%)
RTC:	>= 3 Volt

Electric Power Consumption:

Board:	tbd
RTC:	<= 10 μ A

8.2 Environmental Conditions

Temperature Range:

Operating:	0°C to +60°C (extended temperature on request)
Storage:	-25°C up to +85°C
Shipping:	-25°C up to +85°C, for packaged boards

Temperature Changes:

Operating:	0.5°C per minute, 7.5°C per 30 minutes
Storage:	1.0°C per minute
Shipping:	1.0°C per minute, for packaged boards

Relative Humidity:

Operating:	5% up to 85% (non condensing)
Storage:	5% up to 95% (non condensing)
Shipping:	5% up to 100% (non condensing), for packaged boards

Shock:

Operating:	150m/s ² , 6ms
Storage:	400m/s ² , 6ms
Shipping:	400m/s ² , 6ms, for packaged boards

Vibration:

Operating:	10 up to 58Hz, 0.075mm amplitude
	58 up to 500Hz, 10m/s ²
Storage:	5 up to 9Hz, 3.5mm amplitude
	9 up to 500Hz, 10m/s ²
Shipping:	5 up to 9Hz, 3.5mm amplitude
	9 up to 500Hz, 10m/s ² , for packaged boards



CAUTION

Shock and vibration figures pertain to the motherboard alone and do not include additional components such as heat sinks, memory modules, cables etc.

8.3 Thermal Specifications

The board is specified to operate in an environmental temperature range from 0°C to +60°C (extended temperature on request). Maximum die temperature is 100°C. To keep the processor under this threshold an appropriate cooling solution needs to be applied. This solution has to take typical and maximum power consumption into account. The maximum power consumption may be twice as high and should be used as a basis for the cooling concept. Additional controllers may also affect the cooling concept. The power consumption of such components may be comparable to the consumption of the processor.

The board design includes thermal solution mounting points that will provide the best possible thermal interface between die and solution. Since we take thermal solutions seriously we have several advanced, aggressive cooling solutions in our product portfolio. Please contact your sales representative to order or discuss your thermal solution needs.



CAUTION

The end customer has the responsibility to ensure that the die temperature of the processor does not exceed 100°C. Permanent overheating may destroy the board!

In case the temperature exceeds 100°C the environmental temperature must be reduced. Under certain circumstances sufficient air circulation must be provided.



CAUTION

The CB4052 includes circuitry that will notify an intelligent power supply to shut down if the processor reaches a critical temperature. This is achieved by deasserting the (low-active) PS_ON# signal found on the SM-Bus connector. When PS_ON# is no longer pulled low, an intelligent power supply would take this as a signal to shut down power. For this to work, PS_ON# must be connected to the power supply's PS_ON input. If PS_ON# is not otherwise connected, the CB4052 can be damaged beyond repair if a thermal shutdown event occurs. In rare instances, if power is not shut down, the board will continue to heat up until failure occurs.

9 Support and Service

Beckhoff and their partners around the world offer comprehensive support and service, making available fast and competent assistance with all questions related to Beckhoff products and system solutions.

9.1 Beckhoff's Branch Offices and Representatives

Please contact your Beckhoff branch office or representative for local support and service on Beckhoff products.

The addresses of Beckhoff's branch offices and representatives around the world can be found on her internet pages: <http://www.beckhoff.com>

You will also find further documentation for Beckhoff components there.

9.2 Beckhoff Headquarters

Beckhoff Automation GmbH
Eiserstr. 5
33415 Verl
Germany

phone: +49(0)5246/963-0
fax: +49(0)5246/963-198
e-mail: info@beckhoff.com
web: www.beckhoff.com

9.2.1 Beckhoff Support

Support offers you comprehensive technical assistance, helping you not only with the application of individual Beckhoff products, but also with other, wide-ranging services:

- support
- design, programming and commissioning of complex automation systems
- and extensive training programs for Beckhoff system components

hotline: +49(0)5246/963-157
fax: +49(0)5246/963-9157
e-mail: support@beckhoff.com

9.2.2 Beckhoff Service

The Beckhoff Service Center supports you in all matters of after-sales service:

- on-site service
- repair service
- spare parts service
- hotline service

hotline: +49(0)5246/963-460
fax: +49(0)5246/963-479
e-mail: service@beckhoff.com

I Annex: Post-Codes

Code	Description
01h	The Xgroup-program code is written in the random access memory from address 1000:0 onwards.
03h	Initialise Variable/Routine "Superio_Early_Init".
05h	1. Cancel display 2. Cancel CMOS error flag
07h	1. Cancel 8042 (keyboard controller) Interface Register 2. Initialising and self testing of 8042 (keyboard controller)
08h	1. Test of special keyboard controllers (Winbond 977 super I/O Chip-series). 2. Enabling of the keyboard-interface register
0Ah	1. Disabling of the PS/2 mouse interface (optional). 2. Auto-detection of the connectors for Keyboard and mouse, optional: swap of PS/2 mouse ports and PS/2 interfaces.
0Eh	Test of the F000h-memory segment (Read/Write ability). In case of an error a signal will come out of the loud speakers.
10h	Auto-detection of the flash-rom-type and loading of the suitable Read/Write program into the run time memory segment F000 (it is required for ESCD-data & the DMI-pool-support).
12h	Interface-test of the CMOS RAM-logic (walking 1's"-algorithm). Setting of the power status of the real-time-clock (RTC), afterwards test of register overflow.
14h	Initialising of the chip-set with default values. They can be modified through a software (MODBIN) by the OEM-customer.
16h	Initialise Variable/Routine "Early_Init_Onboard_Generator".
18h	CPU auto-detection (manufacturer, SMI type (Cyrix or Intel), CPU-class (586 or 686)).
1Bh	Initialising if the interrupt pointer table. If nothing else is pretended, the hardware interrupts will point on "SPURIOUS_INT_HDLR and the software interrupts will point on SPURIOUS_soft_HDLR.
1Dh	Initialise Variable/Routine EARLY_PM_INIT.
1Fh	Load the keyboard table (Notebooks)
21h	Initialising of the hardware power management (HPM) (Notebooks)
23h	1. Test the validity of the RTC-values (Example: "5Ah" is an invalid value for an RTC-minute). 2. Load the CMOS-values into the BIOS Stack. Default-values are loaded if CMOS-checksum errors occur. 3. Preparing of the BIOS 'resource map' for the PCI & plug and play configuration. If ESCD is valid, take into consideration the ESCD's legacy information. 4. Initialise the onboard clock generator. Clock circuit at non-used PCI- and DIMM slots. 5. First initialising of PCI-devices: assign PCI-bus numbers - alot memory- & I/O resources - search for functional VGA-controllers and VGA-BIOS and copy the latter into memory segment C000:0 (Video ROM Shadow).
27h	Initialise cache memory for INT 09
29h	1. Program the CPU (internal MTRR at P6 and PII) for the first memory address range (0-640K). 2. Initialising of the APIC at CPUs of the Pentium-class. 3. Program the chip-set according to the settings of the CMOS-set-up (Example: Onboard IDE-controller). 4. Measuring of the CPU clock speed. 5. Initialise the video BIOS.
2Dh	1. Initialise the "Multi-Language"-function of the BIOS 2. Soft copy, e.g. Award-Logo, CPU-type and CPU clock speed...
33h	Keyboard-reset (except super I/O chips of the Winbond 977 series)
3Ch	Test the 8254 (timer device)
3Eh	Test the interrupt Mask bits of IRQ-channel 1 of the interrupt controller 8259.
40h	Test the interrupt Mask bits of IRQ-channel 2 of the interrupt controller 8259
43h	Testing the function of the interrupt controller (8259).
47h	Initialise EISA slot (if existent).

Code	Description
49h	1. Determination of the entire memory size by revising the last 32-Bit double word of each 64k memory segment. 2. Program "write allocation" at AMD K5-CPU's.
4Eh	1. Program MTRR at M1 CPU's 2. Initialise level 2-cache at CPU's of the class P6 and set the "cacheable range" of the random access memory. 3. Initialise APIC at CPU's of the class P6. 4. Only for multiprocessor systems (MP platform): Setting of the "cacheable range" on the respective smallest value (for the case of non-identical values).
50h	Initialise USB interface
52h	Testing of the entire random access memory and deleting of the extended memory (put on "0")
55h	Only for multi processor systems (MP platform): Indicate the number of CPU's.
57h	1. Indicate the plug and play logo 2. First ISA plug and play initialising – CSN-assignment for each identified ISA plug and play device.
59h	Initialise TrendMicro anti virus program code.
5Bh	(Optional:) Indication of the possibility to start AWDFLASH.EXE (Flash ROM programming) from the hard disk.
5Dh	1. Initialise Variable/Routine Init_Onboard_Super_IO. 2. Initialise Variable/Routine Init_Onboard_AUDIO.
60h	Release for starting the CMOS set-up (this means that before this step of POST, users are not able to access the BIOS set-up).
65h	Initialising of the PS/2 mouse.
67h	Information concerning the size of random access memory for function call (INT 15h with AX-Reg. = E820h).
69h	Enable level 2 cache
6Bh	Programming of the chip set register according to the BIOS set-up and auto-detection table.
6Dh	1. Assignment of resources for all ISA plug and play devices. 2. Assignment of the port address for onboard COM-ports (only if an automatic junction has been defined in the setup).
6Fh	1. Initialising of the floppy controller 2. Programming of all relevant registers and variables (floppy and floppy controller).
73h	Optional feature: Call of AWDFLASH.EXE if: - the AWDFLASH program was found on a disk in the floppy drive. - the shortcut ALT+F2 was pressed.
75h	Detection and installation of the IDE drives: HDD, LS120, ZIP, CDROM...
77h	Detection of parallel and serial ports.
7Ah	Co-processor is detected and enabled.
7Fh	1. Switch over to the text mode, the logo output is supported. - Indication of possibly emerged errors. Waiting for keyboard entry. - No errors emerged, respective F1 key was pressed (continue): Deleting of the EPA- or own logo.
82h	1. Call the pointer to the "chip set power management". 2. Load the text font of the EPA-logo (not if a complete picture is displayed) 3. If a password is set, it is asked here.
83h	Saving of the data in the stack, back to CMOS.
84h	Initialising of ISA plug and play boot drives (also Boot-ROMs)
85h	1. Final initialising of the USB-host. 2. At network PC's (Boot-ROM): Construction of a SYSID structure table 3. Backspace the scope presentation into the text mode 4. Initialise the ACPI table (top of memory). 5. Initialise and link ROMs on ISA cards 6. Assignment of PCI-IRQs 7. Initialising of the advanced power management (APM) 8. Set back the IRQ-register.

Code	Description
93h	Reading in of the hard disk boot sector for the inspection through the internal anti virus program (trend anti virus code)
94h	<ol style="list-style-type: none"> 1. Enabling of level 2 cache 2. Setting of the clock speed during the boot process 3. Final initialising of the chip set. 4. Final initialising of the power management. 5. Erase the onscreen and display the overview table (rectangular box). 6. Program "write allocation" at K6 CPUs (AMD) 7. Program "write combining" at P6 CPUs (INTEL)
95h	<ol style="list-style-type: none"> 1. Program the changeover of summer-and winter-time 2. Update settings of keyboard-LED and keyboard repeat rates
96h	<ol style="list-style-type: none"> 1. Multi processor system: generate MP-table 2. Generate and update ESCD-table 3. Correct century settings in the CMOS (20xx or 19xx) 4. Synchronise the DOS-system timer with CMOS-time 5. Generate an MSIRQ-Routing table..
C0h	Chip set initialising: <ul style="list-style-type: none"> - Cut off shadow RAM - Cut off L2 cache (apron 7 or older) - Initialise chip set register
C1h	Memory detection: <ul style="list-style-type: none"> Auto detection of DRAM size, type and error correction (ECC or none) Auto detection of L2 cache size (apron 7 or older)
C3h	Unpacking of the packed BIOS program codes into the random access memory.
C5h	Copying of the BIOS program code into the shadow RAM (segments E000 & F000) via chipset hook.
CFh	Testing of the CMOS read/write functionality
FFh	Boot trial over boot-loader-routine (software-interrupt INT 19h)

II Annex: Resources

A IO Range

The used resources depend on setup settings.

The given values are ranges, which are fixed by AT compatibility. Other IO ranges are used, which are dynamically adjusted by Plug & Play BIOS while booting.

Address	Function
0-FF	Reserved IO area of the board
170-17F	
1F0-1F7	
278-27F	
2E8-2EF	
2F8-2FF	COM2
370-377	
378-37F	LPT1
3BC-3BF	
3E8-3EF	
3F0-3F7	
3F8-3FF	COM1

B Memory Range

The used resources depend on setup settings.

If the entire range is clogged through option ROMs, these functions do not work anymore.

Address	Function
A0000-BFFFF	VGA RAM
C0000-CFFFF	VGA BIOS
D0000-DFFFF	AHCI BIOS / RAID / PXE (if available)
E0000-EFFFF	System BIOS while booting
F0000-FFFFF	System BIOS

C Interrupt

The used resources depend on setup settings.

The listed interrupts and their use are given through AT compatibility.

If interrupts must exclusively be available on the ISA side, they have to be reserved through the BIOS setup. The exclusivity is not given and not possible on the PCI side.

Address	Function
IRQ0	Timer
IRQ1	PS/2 Keyboard
IRQ2 (9)	
IRQ3	COM1
IRQ4	COM2
IRQ5	
IRQ6	
IRQ7	LPT1
IRQ8	RTC
IRQ9	
IRQ10	
IRQ11	

Address	Function
IRQ12	PS/2 Mouse
IRQ13	FPU
IRQ14	
IRQ15	

D PCI Devices

All listed PCI devices exist on the board. Some PCI devices or functions of devices may be disabled in the BIOS setup. Once a device is disabled other devices may get PCI bus numbers different from the ones listed in the table.

AD	INTA	REQ	Bus	Dev.	Fct.	Controller / Slot
	-	-	0	0	0	Host Bridge ID2A40h
	A	-	0	2	0	VGA Graphics ID2A42h
	A	-	0	25	0	LAN ICH9 ID10F5h
	A	-	0	26	0	USB UHCI Controller #4 ID2937h
	B	-	0	26	1	USB UHCI Controller #5 ID2938h
	D	-	0	26	2	USB UHCI Controller #6 ID2939h
	C	-	0	26	7	USB 2.0 EHCI Controller #2 ID293Ch
	A	-	0	27	0	HDA Controller ID293Eh
	A	-	0	28	0	PCI Express Port 1 ID2940h
	A	-	0	28	4	PCI Express Port 5 ID2948h
	A	-	0	29	0	USB UHCI Controller #1 ID2934h
	B	-	0	29	1	USB UHCI Controller #2 ID2935h
	C	-	0	29	2	USB UHCI Controller #3 ID2936h
	A	-	0	29	7	USB 2.0 EHCI Controller #1 ID293Ah
	-	-	0	30	0	DMI-to-PCI Bridge ID2448h
	-	-	0	31	0	LPC Interface ID2917h
	B	-	0	31	2	SATA Interface #1 ID2928h
	B	-	0	31	3	SMBus Interface ID2930h
	A	-	(1)	0	0	LAN external ID10D3h
20	A	0	(2)	4		External Slot 1
21	B	1	(2)	5		External Slot 2
22	C	2	(2)	6		External Slot 3
23	D	3	(2)	7		External Slot 4

E SMB Devices

The following table contains all reserved SM-Bus device addresses in 8-bit notation. Note that external devices must not use any of these addresses even if the component mentioned in the table is not present on the motherboard.

Address	Function
10-11	Standard slave address
40-41	GPIO
60-61	BIOS internal
70-73	POST code output
88-89	BIOS-defined slave address
A0-A1	DIMM 1
A2-A3	DIMM 2
A4-AF	BIOS internal
B0-BF	BIOS internal
D2-D3	Clock