

Original manual | EN

# CB6467

Computerboard





# Table of content

<b>1</b>	<b>Documentation issue status</b>	<b>5</b>
<b>2</b>	<b>Notes on the documentation</b>	<b>6</b>
<b>3</b>	<b>Safety instructions</b>	<b>7</b>
<b>4</b>	<b>Overview</b>	<b>9</b>
4.1	Properties	9
4.2	List of features	10
4.3	Specifications and documents	11
<b>5</b>	<b>Detailed description</b>	<b>12</b>
5.1	Power supply	12
5.2	CPU	12
5.3	Memory	12
5.4	M.2 Key M	12
5.5	M.2 Key B	13
<b>6</b>	<b>External connections</b>	<b>14</b>
6.1	Note on the use of cables	14
6.2	Connector Map	14
6.3	List of interfaces	15
6.4	Front panel: Power supply (X101)	16
6.5	Front panel: LAN 1 – 4 (X102 - X105)	17
6.6	Front panel: USB 3.0 A - D (X106 - X109)	18
6.7	Front panel: DisplayPorts (X110, X111)	19
<b>7</b>	<b>Internal connections</b>	<b>20</b>
7.1	Internal: Memory	20
7.2	Internal: M.2	25
7.3	Internal: BeaCon140 (with Q370)	30
7.4	Internal: FAN	33
7.5	Internal: Battery	34
<b>8</b>	<b>LEDs</b>	<b>35</b>
8.1	LED: Power controller	35
8.2	LED: SATA	36
8.3	LED: TwinCAT	37
8.4	LED: UPS-OCT	38
<b>9</b>	<b>BIOS</b>	<b>39</b>
9.1	Using the setup	39
9.2	Main	40
9.3	Advanced Menu	41
9.3.1	RC ACPI Settings	42
9.3.2	CPU Configuration	43
9.3.3	Trusted Computing	44
9.3.4	ACPI Settings Enabled	44
9.3.5	ACPI Settings Disabled	45
9.3.6	Hardware Monitor	46

9.3.7	AMI Graphic Output Protocol Policy .....	47
9.3.8	PCI Subsystem Settings .....	48
9.3.9	USB Configuration .....	50
9.3.10	NVMe Configuration .....	51
9.3.11	Power Controller Options.....	52
9.3.12	BAsCon* Configuration.....	53
9.3.13	SATA And RST Configuration .....	54
9.3.14	AMT Configuration.....	57
9.3.15	TLs Auth Configuration .....	61
9.3.16	Network Stack Configuration .....	63
9.3.17	Network Stack Configuration enabled .....	63
9.3.18	Intel Rapid Storage Technology .....	64
9.3.19	Driver Health.....	64
9.4	Chipset .....	65
9.4.1	System Agent (SA) Configuration.....	66
9.4.2	PCH-IO Configuration.....	68
9.5	Security.....	74
9.5.1	Secure Boot.....	75
9.6	Boot .....	90
9.6.1	Advanced Fixed Boot Order Parameters.....	91
9.7	Save & Exit.....	92
<b>10</b>	<b>Mechanical drawings .....</b>	<b>93</b>
10.1	PCB: Holes .....	93
10.2	PCB: Pin 1 distances .....	94
10.3	PCB: Dimensions .....	95
<b>11</b>	<b>Technical data.....</b>	<b>96</b>
11.1	Electrical data .....	96
11.2	Environmental conditions .....	96
11.3	Technical specifications.....	97
<b>12</b>	<b>Support and Service.....</b>	<b>98</b>
12.1	Beckhoff Support .....	98
12.2	Beckhoff Service.....	98
12.3	Beckhoff headquarters .....	98
<b>13</b>	<b>Appendix I: Post Codes .....</b>	<b>99</b>
<b>14</b>	<b>Appendix II: Resources.....</b>	<b>100</b>
14.1	Interrupt .....	100
14.2	PCI devices .....	101
14.3	SMB devices.....	102

# 1 Documentation issue status

Version	Modifications
0.1	Preliminary version, mechanical only
0.2	Preliminary version with Bios entries
0.3	Preliminary version with updated BIOS version 0.05
0.4	Preliminary version G2 with Family BIOS 0.07
0.5	Preliminary version G2 with BIOS 0.11 and adapted block diagram
1.0	Initial release, incl. change from BAseCon140 to BeaCon140
1.1	BIOS update to version 0.13 and new front page

## 2 Notes on the documentation

This description is only intended for the use of trained specialists in control and automation engineering who are familiar with the applicable national standards.

It is essential that the documentation and the following notes and explanations are followed when installing and commissioning the components.

It is the duty of the technical personnel to use the documentation published at the respective time of each installation and commissioning.

The responsible staff must ensure that the application or use of the products described satisfy all the requirements for safety, including all the relevant laws, regulations, guidelines and standards.

### Disclaimer

The documentation has been prepared with care. The products described are, however, constantly under development.

We reserve the right to revise and change the documentation at any time and without prior announcement.

No claims for the modification of products that have already been supplied may be made on the basis of the data, diagrams and descriptions in this documentation.

### Trademarks

Beckhoff®, TwinCAT®, EtherCAT®, EtherCAT G®, EtherCAT G10®, EtherCAT P®, Safety over EtherCAT®, TwinSAFE®, XFC®, und XTS® and XPlanar®, are registered trademarks of and licensed by Beckhoff Automation GmbH.

Other designations used in this publication may be trademarks whose use by third parties for their own purposes could violate the rights of the owners.

### Patent Pending

The EtherCAT Technology is covered, including but not limited to the following patent applications and patents:

EP1590927, EP1789857, EP1456722, EP2137893, DE102015105702

with corresponding applications or registrations in various other countries.

**EtherCAT** 

EtherCAT® is registered trademark and patented technology, licensed by Beckhoff Automation GmbH, Germany

### Copyright

© Beckhoff Automation GmbH & Co. KG, Germany.

The reproduction, distribution and utilization of this document as well as the communication of its contents to others without express authorization are prohibited.

Offenders will be held liable for the payment of damages. All rights reserved in the event of the grant of a patent, utility model or design.

### 3 Safety instructions

**Safety regulations**

Please note the following safety instructions and explanations!  
 Product-specific safety instructions can be found on following pages or in the areas mounting, wiring, commissioning etc.

**Exclusion of liability**

All the components are supplied in particular hardware and software configurations appropriate for the application. Modifications to hardware or software configurations other than those described in the documentation are not permitted, and nullify the liability of Beckhoff Automation GmbH & Co. KG.

**Personnel qualification**

This description is only intended for trained specialists in control, automation and drive technology who are familiar with the applicable national standards.

**Description of symbols**

In this documentation the following symbols are used with an accompanying safety instruction or note. The safety instructions must be read carefully and followed without fail!

<b>⚠ DANGER</b>
<p><b>Serious risk of injury!</b></p> <p>Failure to follow the safety instructions associated with this symbol directly endangers the life and health of persons!</p>

<b>⚠ WARNING</b>
<p><b>Risk of injury!</b></p> <p>Failure to follow the safety instructions associated with this symbol endangers the life and health of persons!</p>

<b>⚠ CAUTION</b>
<p><b>Personal injuries!</b></p> <p>Failure to follow the safety instructions associated with this symbol can lead to injuries to persons!</p>

<b>NOTE</b>
<p><b>Damage to the environment or devices</b></p> <p>Failure to follow the instructions associated with this symbol can lead to damage to the environment or equipment.</p>

**i Tip or pointer**  
 This symbol indicates information that contributes to better understanding.

	<p><b>UL note</b></p> <p>This symbol indicates important information regarding UL certification.</p>
---	--

**Intended use**

The CB6467 Computer Board was designed and developed exclusively for configuration in automation processes. To that end the board is equipped with external interfaces in order to acquire or output digital or analog signals or forward them to higher-level components.

Any other use is regarded as inappropriate.

The specified limits for electrical and technical data must be adhered to.



# 4 Overview

## 4.1 Properties

The CB6467 has been designed as a high-performance compact board based on Intel® Coffeelake processors. State-of-the-art DDR4 technology enables a memory extension up to 64 GB using SO-DIMM260.

Two DisplayPort connectors, 4 Gigabit-LAN connectors and 4 USB 3.0 ports are available as standard interfaces on the front panel. *The two DisplayPorts++ enable the connection of an HDMI adapter for an HDMI signal. The connection of an HDMI display with adapter is possible.*

There are two versions available, version 1 with a Q370 chipset and version 2 with an H310 chipset as a low-cost version.

Internally, the CB6467 has an M.2 (B) socket (2280), an M.2 (M) socket (2280) and a BeaCon140 plug. Depending on the chipset in use, various signals are fed out via the internal connectors. These signals are listed in the respective chapter.

Power is supplied via a 4-pin isolated connector on the front panel.

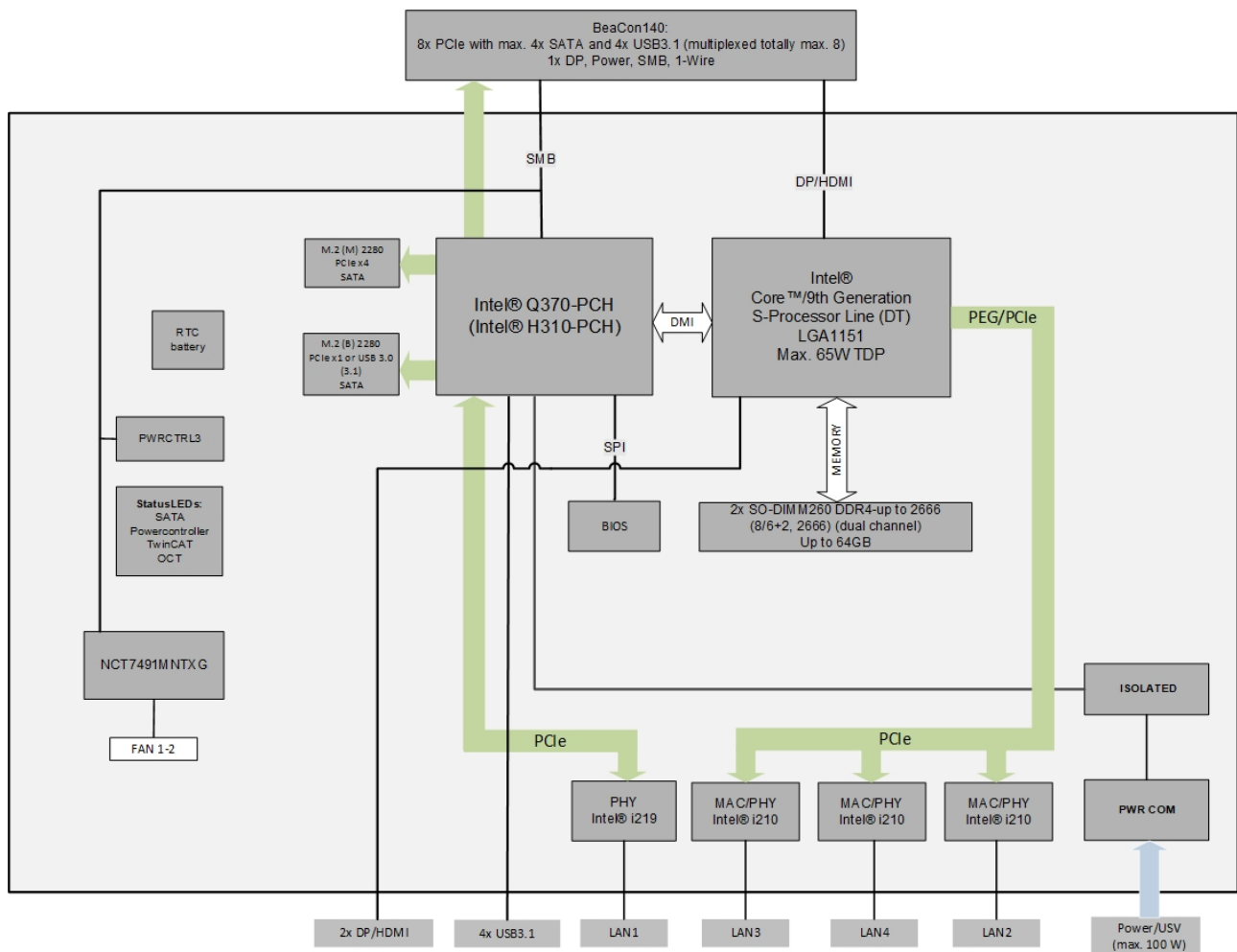

Fig. 1: CB6467 – block diagram

## 4.2 List of features

CB6467	120 x 120 Board
CPU versions	Intel® Celeron® G4900 3.1 GHz, 2 cores, 2 MB LLC Intel® Pentium® G5400 3.7 GHz, 2 cores, 4 MB LLC Intel® Core™ i3-9100E 3.1 GHz, 4 cores, 6 MB LLC Intel® Core™ i5-9500E 3.0 GHz, 6 cores, 9 MB LLC Intel® Core™ i7-9700E 2.6 GHz, 8 cores, 12 MB LLC
Memory	2x SO-DIMM260 1.2 V DDR4-2666 Maximum memory extension 64 GB
I/O on front panel	2x DisplayPort++(connection of an HDMI adapter for an HDMI signal is possible.) 4x GB LAN 4x USB3.0
Internal I/O	1x M.2 (M) socket, signals depend on chipset (see chapter M.2 <a href="#">Internal: M.2 [► 25]</a> ) 1x M.2 (B) socket, signals depend on chipset (see chapter M.2 <a href="#">Internal: M.2 [► 25]</a> ) 1x BeaCon140 (for signals, see chapter <a href="#">BeaCon140 Internal: BeCon140 (with Q370) [► 30]</a> )
Graphic resolution	DisplayPort: 4096x2304@60Hz HDMI1.4: 2560x1600@60 Hz; 4096x2160@24 Hz DVI: 1920x1200@60 Hz
RTC	Exchangeable, horizontal on-board battery Optional: horizontal battery on expansion card
BIOS	AMI® Aptio V
Power supply	24 V (+20 % / -15 %)
Format	120 x 120 mm

### ● Availability of the processors



The list of features lists all the processors that can be ordered. Their actual availability depends on the manufacturer.

### ● Real-time applications



The Ethernet port connected via PCIe is usually suitable for cycle times  $\leq 1$  ms and for distributed clock applications with EtherCAT.  
The Ethernet port integrated in the chipset is usually suitable for real-time Ethernet applications with cycle times  $> 1$  ms (without distributed clocks).

## 4.3 Specifications and documents

The following documents, specifications or webpages were used for the preparation of this manual or as further technical documentation respectively.

- **PCI specification**
  - Version 2.3 or 3.0
  - [www.pcisig.com](http://www.pcisig.com)
- **PCI Express® Base Specification**
  - Version 5.0
  - [www.pcisig.com](http://www.pcisig.com)
- **ACPI specification**
  - Version 5.0
  - [www.acpi.info](http://www.acpi.info)
- **ATA/ATAPI specification**
  - Version 7 Rev. 1
  - [www.t13.org](http://www.t13.org)
- **USB specifications**
  - [www.usb.org](http://www.usb.org)
- **SM-Bus specification**
  - Version 2.0
  - [www.smbus.org](http://www.smbus.org)
- **Intel® chip descriptions**
  - Intel® Core™ processor product family data sheet
  - [www.intel.com](http://www.intel.com)
- **Intel® chip description**
  - I219 data sheet
  - i210 datasheet
  - [www.intel.com](http://www.intel.com)
- **SMSC® chip description**
  - SCH3114 datasheet (NDA required)
  - [www.smsc.com](http://www.smsc.com)
- **American Megatrends®**
  - Aptio™ Text Setup Environment (TSE) User Manual
  - [www.ami.com](http://www.ami.com)
- **American Megatrends®**
  - Aptio™ 5.x Status Codes
  - [www.ami.com](http://www.ami.com)

## 5 Detailed description

### 5.1 Power supply

The board is supplied with an isolated input voltage with a nominal rating of 24 V. In normal operation the DC/DC power rail is supplied with this voltage. A UPS can also be implemented via an OCT signal (OCT = One Cable Technology).



#### UPS-OCT

The UPS OCT can only be implemented with the Beckhoff CU81XX-xxxx UPS.

---

### 5.2 CPU

Intel® Core processors of the 8<sup>th</sup> and 9<sup>th</sup> generation (Coffee Lake and Coffee Lake Refresh) are used. The processors of both generations are characterized by very low power consumption and offer contemporary performance with clock rates of currently up to 4.4 GHz (max. turbo clock frequency).

### 5.3 Memory

SO-DIMM260 memory modules (DDR4-2666), as commonly used in notebooks, are used on the CB6467 board. For technical and mechanical reasons, it is possible that certain memory modules cannot be used. Information regarding the recommended memory modules can be obtained from your distributor.

Depending on the product version, a memory extension up to 64 GB is possible with the currently available SO-DIMM260 modules. Care should be taken to ensure that the same memory modules are inserted in both memory sockets.

### 5.4 M.2 Key M

Expansion cards that fulfill the M.2 specification are characterized by an extremely small format and – depending on the card type – flexible dimensions.

M.2 cards can easily and simply be inserted by plugging them into the slot and fixing them with a screw.

This M.2 socket (2280) of the CB6467 supports Key M. Different signals are supported, depending on the chipset used. The table in chapter M.2 lists all the interfaces supported, depending on the chipset in use.



#### Driver compatibility

For optimum driver compatibility, we recommend the use of a Microsoft® Windows 10 operating system.

---

## 5.5 M.2 Key B

Expansion cards that fulfill the M.2 specification are characterized by an extremely small format and – depending on the card type – flexible dimensions.

M.2 cards can easily and simply be inserted by plugging them into the slot and fixing them with a screw.

This M.2 socket (2280) of the CB6467 supports Key B. Different signals are supported, depending on the chipset used. The table in chapter M.2 lists all the interfaces supported, depending on the chipset in use.

---

### **i** Driver compatibility

For optimum driver compatibility, we recommend the use of a Microsoft® Windows 10 operating system.

---

## 6 External connections

### 6.1 Note on the use of cables

**i** **Requirement for the cabling!**

The cables used must meet certain requirements for most interfaces. For example, twisted and shielded cables are necessary for a reliable USB 2.0 connection. Limitations in the maximum cable length are also no rarity. All of these interface-specific requirements are to be taken from the respective specifications and observed accordingly.

### 6.2 Connector Map

The plug connections on the component side of the CB6467 board are summarized in the illustration below. The function of the respective connector can be taken from the table below the illustration, as can the page of the manual on which further information about this connection can be read.

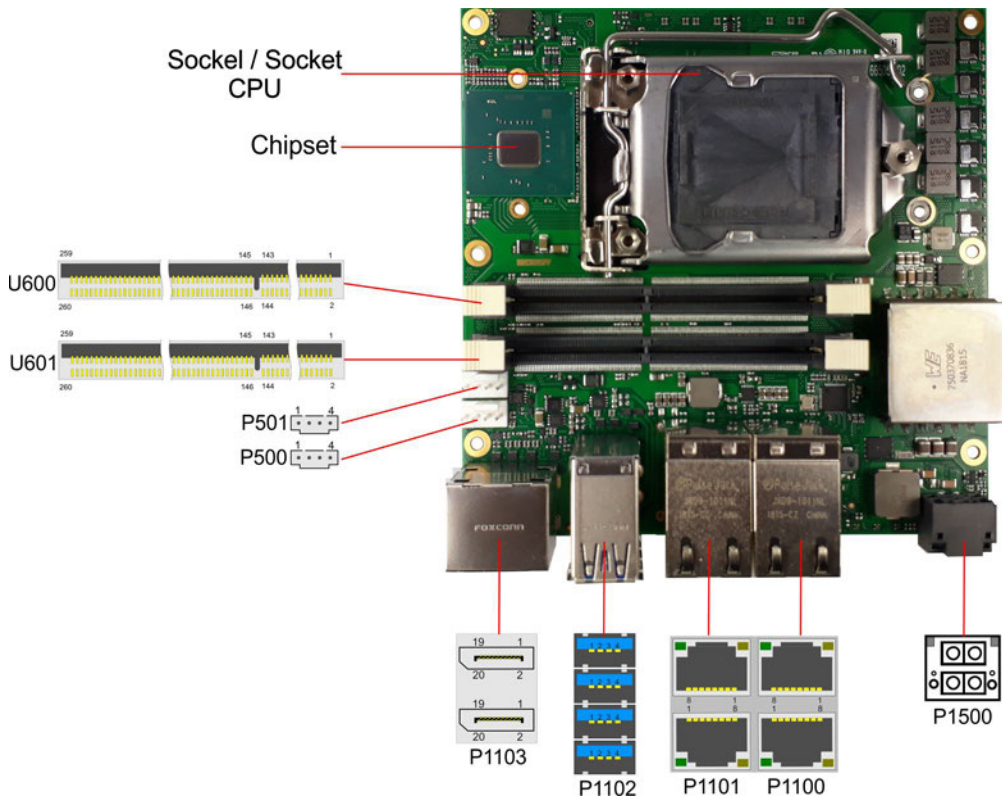

Fig. 2: CB6467 connector map

## 6.3 List of interfaces

Number	Function (designation)	Page
P1500	Vin (X101)	Front panel: Power supply (X101) [ <a href="#">▶ 16</a> ]
P1100	LAN 1 (X102)	Front panel: LAN 1 – 4 (X102 - X105) [ <a href="#">▶ 17</a> ]
P1100	LAN 2 (X103)	Front panel: LAN 1 – 4 (X102 - X105) [ <a href="#">▶ 17</a> ]
P1101	LAN 3 (X104)	Front panel: LAN 1 – 4 (X102 - X105) [ <a href="#">▶ 17</a> ]
P1101	LAN 4 (X105)	Front panel: LAN 1 – 4 (X102 - X105) [ <a href="#">▶ 17</a> ]
P1102	USB3.0 (X106)	Front panel: USB 3.0 A - D (X106 - X109) [ <a href="#">▶ 18</a> ]
P1102	USB3.0 (X107)	Front panel: USB 3.0 A - D (X106 - X109) [ <a href="#">▶ 18</a> ]
P1102	USB3.0 (X108)	Front panel: USB 3.0 A - D (X106 - X109) [ <a href="#">▶ 18</a> ]
P1102	USB3.0 (X109)	Front panel: USB 3.0 A - D (X106 - X109) [ <a href="#">▶ 18</a> ]
P1103	DisplayPorts (X110, X111)	Front panel: DisplayPorts (X110, X111) [ <a href="#">▶ 19</a> ]
P1200*	M.2 (Key M) 2280	Internal: M.2 [ <a href="#">▶ 25</a> ]
P1201*	M.2 (Key B) 2280	Internal: M.2 [ <a href="#">▶ 25</a> ]
P1203*	BeaCon140	Internal: BeaCon140 (with Q370) [ <a href="#">▶ 30</a> ]
P500/501	FAN	Internal: FAN [ <a href="#">▶ 33</a> ]
BT1200*	Battery	Internal: Battery [ <a href="#">▶ 34</a> ]
U600	SODIMM	Internal: Memory [ <a href="#">▶ 20</a> ]
U601	SODIMM	Internal: Memory [ <a href="#">▶ 20</a> ]

\*not shown (see underside of the board)



The numbers in brackets correspond to the labeling of the external interfaces on the housing on the front panel of the Industrial PC.

## 6.4 Front panel: Power supply (X101)

The connection to the power supply is implemented as a 2x2-pin housing plug (Phoenix Contact P20THR-1818504). The main supply voltage (24 V) for the module is on PIN 3. This can also be implemented as UPS-OCT (One Cable Technology), i.e. the signal for the UPS is also transmitted to the board via this cable.

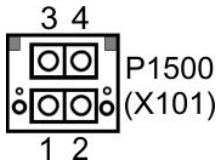

Fig. 3: CB6467 power supply (X101)

### ● 90° plug

**i** As the plug is a 90° plug, the plug symbol in the illustration is oriented to what you see when you look at the board from the side (instead of from above).

Pin assignment of the power plug:					
Description	Signal	Pin		Signal	Description
PC_On: Input for starting and shutting down the PC. Low (0 V or open contact): PC starts. High (>3 V): PC shuts down.	PC_On	1	3	Vin	24 V supply voltage UPS-OCT is supported.
Power status: Output of the Power Status. The voltage corresponds to the positive supply voltage and can be loaded up to 500 mA. Low (0 V): PC is off. High (Vin): PC is on.	PC_ACTIVE	2	4	GND	Ground



## 6.5 Front panel: LAN 1 – 4 (X102 - X105)

The board has four Gigabit-LAN connections, which are implemented with 2 standard connectors, each with two connections. Network components compatible with 10BaseT, 100BaseT and 1000BaseT can be connected to all of them. The required speed is selected automatically. Auto-Cross and Auto-Negotiate are available as well as PXE, RPL and WOL functionality. Intel® i219 (PHY) is the controller for LAN1, while Intel® i210 (MAC/PHY) is used as the controller for LAN 2 to 4.

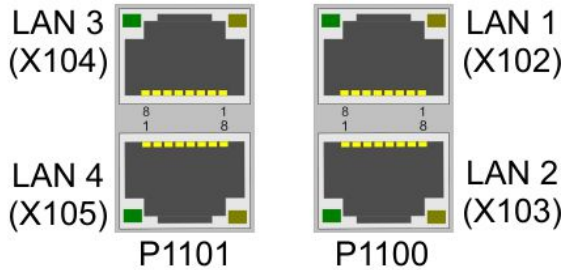

Fig. 4: CB6467 LAN (X102-X105)

### ● Real-time applications



The Ethernet port connected via PCIe is usually suitable for cycle times  $\leq 1$  ms and for distributed clock applications with EtherCAT. The Ethernet port integrated in the chipset is usually suitable for real-time Ethernet applications with cycle times  $> 1$  ms (without distributed clocks).

### ● 90° plug



As the plug is a 90° plug, the plug symbol in the illustration is oriented to what you see when you look at the board from the side (instead of from above).

The LEDs of the LAN interfaces indicate the activity and speed of the data transmission:

Mbit/s	Flashing during data transmission	Steadily lit
1000	Green	Green
100	Green	Orange
10	Green	None

## 6.6 Front panel: USB 3.0 A - D (X106 - X109)

The CB6467 provides four USB3.0 ports in a combination connector.

The USB channels support the USB specification 3.0. All necessary settings for USB can be made by the BIOS. Note that the "USB mouse and keyboard" function in the BIOS setup is only required if the operating system does not offer USB support. This function should not be selected for settings in the setup and for booting Windows with a USB mouse and keyboard connected, because this would lead to considerable performance limitations.

The individual USB interfaces can supply a current of up to 900 mA and are electronically protected.

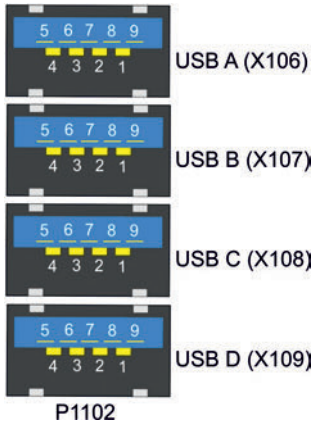

Fig. 5: CB6467 USB (X106-X109)

### ● Switch-off of the USB ports by overcurrent protection

**i** USB ports A and B and USB ports C and D are each protected by a common overcurrent detection. In the event of overcurrent occurring on one of the ports, therefore, both commonly protected USB ports will be switched off.

### ● 90° plug

**i** As the plug is a 90° plug, the plug symbol in the illustration is oriented to what you see when you look at the board from the side (instead of from above).

## 6.7 Front panel: DisplayPorts (X110, X111)

For devices with a DisplayPort connection a corresponding standard connector (Foxconn 3VD11203-DPA1-4H) with two DisplayPort connections is available.

The interface additionally provides HDMI/DVI signals that can be used with aid of an adapter. Please consult your distributor with regard to a suitable adapter.

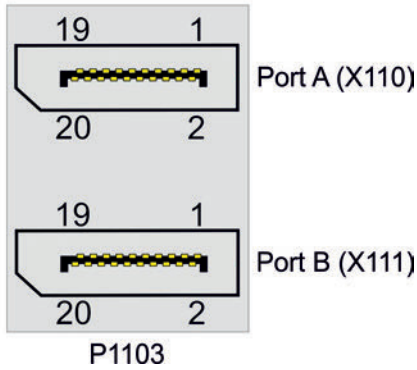

Fig. 6: CB6467 Display Port (X110-X111)

### ● 90° plug

**i** As the plug is a 90° plug, the plug symbol in the illustration is oriented to what you see when you look at the board from the side (instead of from above).

Pin assignment of DisplayPort plug:					
Description	Signal	Pin		Signal	Description
Display Port Lane 0 +	L0	1	2	GND	Ground
Display Port Lane 0 -	L#0	3	4	L1	Display Port Lane 1 +
Ground	GND	5	6	L#1	Line 1 -
Display Port Lane 2 +	L2	7	8	GND	Ground
Display Port Lane 2 -	L#2	9	10	L3	Display Port Lane 3 +
Ground	GND	11	12	L#3	Display Port Lane 3 -
DP / HDMI	HDMI#	13	14	GND	Ground
Auxiliary plus	AUX	15	16	GND	Ground
Auxiliary minus	AUX#	17	18	HPD	Hot Plug Detect
Ground	GND	19	20	3.3 V	Supply voltage 3.3 V

### ● Switching to HDMI

**i** DisplayPort signals are led out via the interface by default. With the use of a level shifter cable the board switches the DisplayPort specification 1.1 automatically to HDMI signals.

## 7 Internal connections

### 7.1 Internal: Memory

On the CB6467 board there are two SO-DIMM260 memory sockets for DDR4-2666 RAM. For technical and mechanical reasons, it is possible that certain memory modules cannot be used. Information regarding the recommended memory modules can be obtained from your distributor.

With two sockets, a memory extension up to 64 GB is possible with currently available modules. Identical memory modules should be inserted in the two memory sockets.

All timing parameters for the different makes and versions are automatically set by the BIOS.

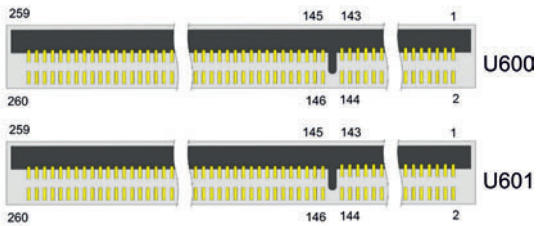

Fig. 7: CB6467 SODIMM

Memory socket pin assignment:					
Description	Signal	Pin1		Signal	Description
Ground	GND	1	2	GND	Ground
Data line 5	DQ5	3	4	DQ4	Data line 4
Ground	GND	5	6	GND	Ground
Data line 1	DQ1	7	8	DQ0	Data line 0
Ground	GND	9	10	GND	Ground
Data strobe 0 -	DQS0_c	11	12	NC	Reserved
Data strobe 0 +	DQS0_t	13	14	GND	Ground
Ground	GND	15	16	DQ6	Data line 6
Data line 7	DQ7	17	18	GND	Ground
Ground	GND	19	20	DQ2	Data line 2
Data line 3	DQ3	21	22	GND	Ground
Ground	GND	23	24	DQ12	Data line 12
Data line 13	DQ13	25	26	GND	Ground
Ground	GND	27	28	DQ8	Data line 8
Data line 9	DQ9	29	30	GND	Ground
Ground	GND	31	32	DQS1_c	Data strobe 1 -
Reserved	NC	33	34	DQS1_t	Data strobe 1 +
Ground	GND	35	36	GND	Ground
Data line 15	DQ15	37	38	DQ14	Data line 14
Ground	GND	39	40	GND	Ground
Data line 10	DQ10	41	42	DQ11	Data line 11
Ground	GND	43	44	GND	Ground
Data line 21	DQ21	45	46	DQ20	Data line 20
Ground	GND	47	48	GND	Ground
Data line 17	DQ17	49	50	DQ16	Data line 16
Ground	GND	51	52	GND	Ground
Data strobe 2 -	DQS2_c	53	54	NC	Reserved
Data strobe 2 +	DQS2_t	55	56	GND	Ground
Ground	GND	57	58	DQ22	Data line 22
Data line 23	DQ23	59	60	GND	Ground
Ground	GND	61	62	DQ18	Data line 18
Data line 19	DQ19	63	64	GND	Ground
Ground	GND	65	66	DQ28	Data line 28
Data line 29	DQ29	67	68	GND	Ground
Ground	GND	69	70	DQ24	Data line 24
Data line 25	DQ25	71	72	GND	Ground
Ground	GND	73	74	DQS3_c	Data strobe 3 -
Reserved	NC	75	76	DQS3_t	Data strobe 3 +
Ground	GND	77	78	GND	Ground
Data line 30	DQ30	79	80	DQ31	Data line 31
Ground	GND	81	82	GND	Ground
Data line 26	DQ26	83	84	DQ27	Data line 27
Ground	GND	85	86	GND	Ground
Reserved	NC	87	88	NC	Reserved
Ground	GND	89	90	GND	Ground
Reserved	NC	91	92	NC	Reserved
Ground	GND	93	94	GND	Ground

Memory socket pin assignment:					
Description	Signal	Pin1		Signal	Description
Data strobe 8 -	DQS8_c	95	96	NC	Reserved
Data strobe 8 +	DQS8_t	97	98	GND	Ground
Ground	GND	99	100	NC	Reserved
Reserved	NC	101	102	GND	Ground
Ground	GND	103	104	N C	Reserved
Reserved	NC	105	106	GND	Ground
Ground	GND	107	108	RESET_n	Reset
Clock Enable 0	CKE0	109	110	CKE1	Clock Enable 1
Supply voltage 1.2 V	VCC	111	112	VCC	Supply voltage 1.2 V
Bank Group Input 1	BG1	113	114	ACT_n	Activation Command Input
Bank Group Input 0	BG0	115	116	ALERT_n	Alert
Supply voltage 1.2 V	VCC	117	118	VCC	Supply voltage 1.2 V
Address line 12	A12	119	120	A11	Address line 11
Address line 9	A9	121	122	A7	Address line 7
Supply voltage 1.2 V	VCC	123	124	VCC	Supply voltage 1.2 V
Address line 8	A8	125	126	A5	Address line 5
Address line 6	A6	127	128	A4	Address line 4
Supply voltage 1.2 V	VCC	129	130	VCC	Supply voltage 1.2 V
Address line 3	A3	131	132	A2	Address line 2
Address line 1	A1	133	134	EVENT_n	Event
Supply voltage 1.2 V	VCC	135	136	VCC	Supply voltage 1.2 V
Clock Signal 0 +	CK0_t	137	138	CK1_t	Clock 1+
Clock Signal 0 -	CK0_c	139	140	CK1_c	Clock 1 -
Supply voltage 1.2 V	VCC	141	142	VCC	Supply voltage 1.2 V
Even parity check	Parity	143	144	A0	Address line 0
SDRAM Bank 2	BA1	145	146	A10/AP	Address line 10/Autoprecharge
Supply voltage 1.2 V	VCC	147	148	VCC	Supply voltage 1.2 V
Chip Select 0	CS0_n	149	150	BA0	Bank Address 0
Address line 14/Write Enable	A14/WE_n	151	152	A16/RAS_n	Address line 16/Row Address Strobe
Supply voltage 1.2 V	VCC	153	154	VCC	Supply voltage 1.2 V
On Die Termination 0	ODT0	155	156	A15/CAS_n	Address line 15/Column Address Strobe
Chip Select 1	CS1_n	157	158	A13	Address line 13
1.2 V	VCC	159	160	VCC	Supply voltage 1.2 V
On Die Termination 1	ODT1	161	162	NC	Reserved
Supply voltage 1.2 V	VCC	163	164	VREFCA	Reference voltage
Reserved	NC	165	166	SA2	SPD Address 2

Memory socket pin assignment:					
Description	Signal	Pin1		Signal	Description
Ground	GND	167	168	GND	Ground
Data line 37	DQ37	169	170	DQ36	Data line 36
Ground	GND	171	172	GND	Ground
Data line 33	DQ33	173	174	DQ32	Data line 32
Ground	GND	175	176	GND	Ground
Data strobe 4 -	DQS4_c	177	178	NC	Reserved
Data strobe 4 +	DQS4_t	179	180	GND	Ground
Ground	GND	181	182	DQ39	Data line 39
Data line 38	DQ38	183	184	GND	Ground
Ground	GND	185	186	DQ35	Data line 35
Data line 34	DQ34	187	188	GND	Ground
Ground	GND	189	190	DQ45	Data line 45
Data line 44	DQ44	191	192	GND	Ground
Ground	GND	193	194	DQ41	Data line 41
Data line 40	DQ40	195	196	GND	Ground
Ground	GND	197	198	DQS5_c	Data strobe 5 -
Reserved	NC	199	200	DQS5_t	Data strobe 5 +
Ground	GND	201	202	GND	Ground
Data line 46	DQ46	203	204	DQ47	Data line 47
Ground	GND	205	206	GND	Ground
Data line 42	DQ42	207	208	DQ43	Data line 43
Ground	GND	209	210	GND	Ground
Data line 52	DQ52	211	212	DQ53	Data line 53
Ground	GND	213	214	GND	Ground
Data line 49	DQ49	215	216	DQ48	Data line 48
Ground	GND	217	218	GND	Ground
Data strobe 6 -	DQS6_c	219	220	NC	Reserved
Data strobe 6 +	DQS6_t	221	222	GND	Ground
Ground	GND	223	224	DQ54	Data line 54
Data line 55	DQ55	225	226	GND	Ground
Ground	GND	227	228	DQ50	Data line 50
Data line 51	DQ51	229	230	GND	Ground
Ground	GND	231	232	DQ60	Data line 60
Data line 61	DQ61	233	234	GND	Ground
Ground	GND	235	236	DQ57	Data line 57
Data line 56	DQ56	237	238	GND	Ground
Ground	GND	239	240	DQS7_c	Data strobe 7 -
Reserved	NC	241	242	DQS7_t	Data strobe 7 +
Ground	GND	243	244	GND	Ground
Data line 62	DQ62	245	246	DQ63	Data line 63
Ground	GND	247	248	GND	Ground
Data line 58	DQ58	249	250	DQ59	Data line 59
Ground	GND	251	252	GND	Ground
SMBus Clock	SCL	253	254	SDA	SMBus data
I <sup>2</sup> C power for SPD EEPROM	VCCSPD	255	256	SA0	SPD Address 0

<b>Memory socket pin assignment:</b>					
<b>Description</b>	<b>Signal</b>	<b>Pin1</b>		<b>Signal</b>	<b>Description</b>
DRAM Activating Power	VPP	257	258	VTT	Termination voltage
DRAM Activating Power	VPP	259	260	SA1	SPD Address 1



## 7.2 Internal: M.2

The CB6467 is equipped with two M.2 sockets, into which an M.2-2280 card (Key M, P1200) and an M.2-2280 card (Key B, P1201) can be inserted. Adapter cards with standard plug connectors are available as accessories. Please contact your distributor for this.

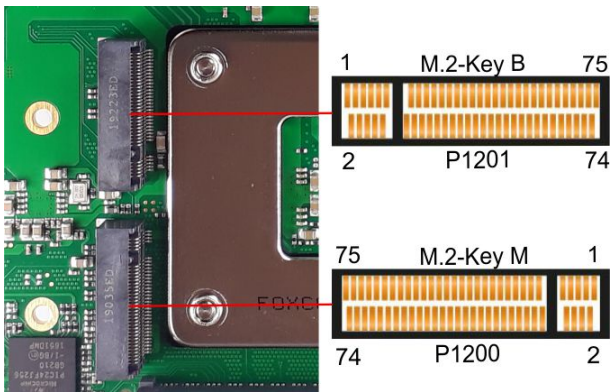

Fig. 8: CB6467 M.2 cut-out

Pin assignment M.2 (Key M):					
Description	Signal	Pin		Signal	Description
Ground	GND	1	2	3.3 V1	Standby supply voltage S3.3 V
Ground	GND	3	4	3.3 V2	Standby supply voltage S3.3 V
PCIe Lane Receive -	PER3#	5	6	N/C	(not led out)
PCIe Lane Receive +	PER3	7	8	N/C	(not led out)
Ground	GND	9	10	GPIO9 DAS DDS LED1	(not led out)
PCIe Lane Transmit -	PET3#	11	12	3.3 V3	Standby supply voltage S3.3 V
PCIe Lane Transmit +	PET3	13	14	3.3 V4	Standby supply voltage S3.3 V
Ground	GND	15	16	3.3 V5	Standby supply voltage S3.3 V
PCIe Lane Receive -	PER2#	17	18	3.3 V6	Standby supply voltage S3.3 V
PCIe Lane Receive +	PER2	19	20	N/C	(not led out)
Configuration pin	Config 0	21	22	N/C	(not led out)
PCIe Lane Transmit -	PET2#	23	24	N/C	(not led out)
PCIe Lane Transmit +	PET2	25	26	N/C	(not led out)
Ground	GND	27	28	N/C	(not led out)
PCIe Lane Receive -	PER1#	29	30	N/C	(not led out)
PCIe Lane Receive	PER1	31	32	N/C	(not led out)
Ground	GND	33	34	N/C	(not led out)
PCIe Lane Transmit -	PET1#	35	36	N/C	(not led out)
PCIe Lane Transmit +	PET1	37	38	DEVSLP	DeviceSleep
Ground	GND	39	40	N/C	(not led out)
PCIe Lane 1 Receive +	PER0# SATAB	41	42	N/C	(not led out)
PCIe Lane 1 Receive -	PER0 SATAB#	43	44	N/C	(not led out)
Ground	GND	45	46	N/C	(not led out)
PCIe Lane 1 Transmit -	PET0# SATAA#	47	48	N/C	(not led out)
PCIe Lane 1 Transmit +	PET0 SATAA	49	50	PRST#	PCIe Reset active low
Ground	GND	51	52	CLKREQ#	PCIe Clock Enable active low
PCIe Lane 1 Reference Clock -	REFCLK#	53	54	PEWAKE#	Link Reactivation active low
PCIe Lane 1 Reference Clock +	REFCLK	55	56	N/C	(not led out)
Ground	GND	57	58	N/C	(not led out)
(not led out)	N/C	59	60	N/C	(not led out)

Pin assignment M.2 (Key M):					
Description	Signal	Pin		Signal	Description
(not led out)	N/C	61	62	N/C	(not led out)
(not led out)	N/C	63	64	N/C	(not led out)
(not led out)	N/C	65	66	N/C	(not led out)
Reset	N/C	67	68	SUSCLK	System clock
Configuration pin	CFG1	69	70	3.3 V	Standby supply voltage S3.3 V
Ground	GND	71	72	3.3 V	Standby supply voltage S3.3 V
Ground	GND	73	74	3.3V	Standby supply voltage S3.3V
Ground	GND	75			

Pin assignment M.2 (Key B):					
Description	Signal	Pin		Signal	Description
Configuration pin	CONFIG_3	1	2	3.3 V1	Standby supply voltage S3.3 V
Ground	GND	3	4	3.3 V2	Standby supply voltage S3.3 V
Ground	GND	5	6	FCPWROFF#	Full Card Power OFF active low
USB data +	USB D+	7	8	WDISABLE#	(not led out)
USB data -	USB D-	9	10	GPIO9 DAS DDS LED1	(not led out)
Ground	GND	11	12	Connector Key	
Connector Key		13	14		
		15	16		
		17	18		
		19	20		
Configuration pin	Config 0	21	22	GPIO6	(not led out)
(not led out)	GPIO11	23	24	GPIO7	(not led out)
(not led out)	DPR	25	26	GPIO10	(not led out)
Ground	GND	27	28	GPIO8	(not led out)
USB 3.0 SuperSpeed Receive -	PER1# USB3RX# SSICRX#	29	30	UIM RST	(not led out)
USB 3.0 SuperSpeed Receive	PER1 USB3RX SSICRX	31	32	UIM CLK	(not led out)
Ground	GND	33	34	UIM DATA	(not led out)
USB 3.0 SuperSpeed Transmit -	PET1# USB3TX# SSICTX#	35	36	UIM PWR	(not led out)
USB 3.0 SuperSpeed Transmit +	PET1 USB3TX SSICTX	37	38	DEVSLP	DeviceSleep
Ground	GND	39	40	GPIO0	(not led out)
PCIe Lane 1 Receive +	PER0# SATAB	41	42	GPIO1	(not led out)
PCIe Lane 1 Receive -	PER0 SATAB#	43	44	GPIO2	(not led out)
Ground	GND	45	46	GPIO3	(not led out)
PCIe Lane 1 Transmit -	PET0# SATAA#	47	48	GPIO4	(not led out)
PCIe Lane 1 Transmit +	PET0 SATAA	49	50	PRST#	PCIe Reset active low
Ground	GND	51	52	CLKREQ#	PCIe Clock Enable active low
PCIe Lane 1 Reference Clock -	REFCLK#	53	54	PEWAKE#	Link Reactivation active low
PCIe Lane 1 Reference Clock +	REFCLK	55	56	N/C	(not led out)
Ground	GND	57	58	N/C	(not led out)

Pin assignment M.2 (Key B):					
Description	Signal	Pin		Signal	Description
(not led out)	ANTCTL0	59	60	COEX3	(not led out)
(not led out)	ANTCTL1	61	62	COEX2	(not led out)
(not led out)	ANTCTL2	63	64	COEX1	(not led out)
(not led out)	ANTCTL3	65	66	SIM DETECT	(not led out)
Power good	RESET#	67	68	SUSCLK	System clock
Configuration pin	CFG1	69	70	3.3 V	Standby supply voltage S3.3 V
Ground	GND	71	72	3.3 V	Standby supply voltage S3.3 V
Ground	GND	73	74	3.3V	Standby supply voltage S3.3V
Configuration pin	CFG2	75			

### 7.3 Internal: BeaCon140 (with Q370)

In conjunction with the Q370 chipset, the BeaCon140 connector enables the flexible extension of the I/O functions of the CB6467. It provides up to 8 PCIe lanes, of which a maximum of 4 can be multiplexed with SATA 2.0 (3G) and a maximum of 4 with PCIe lines, as well as a maximum of 4 PCIe lines with a maximum of 4 USB3.0 lines (see table). DisplayPort, SSIC, SMBus and 1-Wire signals can be fed out via the BeaCon140 connector. The extension board takes care of the configuration of the IO functions. A PIC on the expansion card contains the configuration data, which are communicated to the board upon connection and thus enable an uncomplicated and self-configuring extension of the I/O options.

#### **● Observe the current limits!**

# i

In order to avoid damaging the device, it is essential to observe the following current limits:

A maximum load of 2.8 A per pin must not be exceeded. On account of the different current consumptions of the usable processors the actual current consumption may be lower. The respective maximum values can be obtained from your distributor on inquiry.

Irrespective of the CPU in use, a maximum total load of 100 W must not be exceeded.

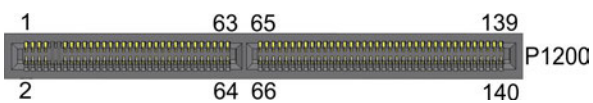

Fig. 9: CB6467 BeaCon

Pin assignment of BeaCon140 connector:					
Description	Signal	Pin		Signal	Description
P_VLoad 24 V SUSV output	VOLOAD/ P_VOLOAD1	2	1	P_VIN1/VIN1	V_IN SUSV input
P_VLoad 24 V SUSV output	VOLOAD/ P_VOLOAD2	4	3	S UPS IN2	P_VIN SUSV input
(not led out)	5 V NC1	6	5	GND	Ground
(not led out)	5 V NC2	8	7	GND	Ground
<b>INSULATION</b>					
S VCC	S5V	14	13	S3.3 V	Standby supply voltage 3.3 V
Ground	GND	16	15	GND	Ground
PCIe Lane 1 Transmit +	PE1 TX/ SATA4 TX	18	17	SATA4 RX/ PE1 RX	PCIe Lane 1 Receive +
PCIe Lane 1 Transmit -	PE1 TX#/ SATA4 TX#	20	19	SATA4 RX #/ PE1 RX#	PCIe Lane 1 Receive -
Ground	GND	22	21	GND	Ground
PCIe Clock Lane 1 +	PECLK1	24	23	PECLK2	PCIe Clock Lane 2 +
PCIe Clock Lane 1 -	PECLK1#	26	25	PECLK2#	PCIe Clock Lane 2 -
Ground	GND	28	27	GND	Ground
PCI Lane 2 Transmit +	PE2 TX/ SATA3 TX	30	29	SATA3 RX/ PE2 RX	PCIe Lane 2 Receive
PCI Lane 2 Transmit -	PE2 TX#/ SATA3 TX#	32	31	SATA3 RX#/ PE2 RX#	PCIe Lane 2 Receive -
Ground	GND	34	33	GND	Ground
PCIe Lane 3 Transmit +	PE3-TX/ SATA2-TX	36	35	SATA2 RX/ PE3 RX	PCIe Lane 3 Receive +
PCIe Lane 3 Transmit -	PE3-TX#/ SATA2-TX#	38	37	SATA2 RX#/ PE3 RX#	PCIe Lane 3 Receive -
Ground	GND	40	39	GND	Ground
PCIe Lane 3 Clock +	PECLK3	42	41	PECLK4	PCIe Clock 4 +
PCIe Lane 3 Clock 3 -	PECLK3#	44	43	PECLK4#	PCIe Clock 4 -
Ground	GND	46	45	GND	Ground
SATA Lane 2 Transmit +	PE4-TX/ SATA1-TX	48	47	SATA1 RX/ PE4 RX	SATA Lane 2 Receive +
SATA Lane 2 Transmit -	PE4-TX#/ SATA1-TX#	50	49	SATA1 RX#/ PE4 RX#	SATA Lane 2 Receive -
Ground	GND	52	51	GND	Ground
PCIe Clock Enable Lane 1 active low	PCKE1#/ DEVSLP4	54	53	PCKE2#/ DEVSLP3	PCIe Lane 2 Clock Enable active low
PCIe Clock Enable Lane 3 -	PCKE3#/ DEVSLP2	56	55	PCKE4#/ DEVSLP1	PCIe Lane 4 Clock Enable -
PCIe Reset active low	PERST#	58	57	PEWAKE#	PCIe Wake active low
SMBus Clock	SMBCLK	60	59	SMBDAT	SMBus Datad
<b>KEY</b>					
SMBus Alert active low	SMB-Alert#	62	61	1Wire	1-Wire

Pin assignment of BeaCon140 connector:					
Description	Signal	Pin		Signal	Description
PCIe Clock Enable Lane 5	PCKE5/OC4#	64	63	PCKE6#/OC3#	PCIe Lane 6 Clock Enable 6 -
<b>KEY</b>					
PCIe Clock Enable Lane 7	PCKE7/OC2#	66	65	PCKE8#/OC1#	USB Overcurrent active low
Ground	GND	68	67	GND	Ground
PCIe Lane 5 Transmit +	PE5-TX/ USB3-4-TX/ USBC1-TX	70	69	USBC1 RX/ USB3-4 RX/ PE5 RX	PCIe Lane 5 Receive +
PCIe Lane 5 Transmit -	PE5-TX#/ USB3-4-TX#/ USBC1_TX#	72	71	USBC1 RX#/ USB3-4 RX# PE5 RX#	PCIe Lane 5 Receive -
USB 2.0 Channel 7 +	USB2-4# (GND)	74	73	USB2-3 (GND)	USB 2.0 Channel 8 Data +
PCIe Clock Lane 5 +	PECLK5/ USBC-SBU1 (GND)	76	75	PECLK6 (GND)	PCIe Lane 6 Clock +
PCIe Clock 5 -	PECLK5#/ USBC-SBU2 (GND)	78	77	PECLK6# (GND)	PCIe Clock Lane 6 -
USB 2.0 Channel 7 -	USB2-4# (GND)	80	79	USB2-3 D# (GND)	USB 2.0 channel 8
PCIe Lane 6 Transmit +	PE6-TX/ USB3-3-TX/ USBC2-TX	82	81	USBC2 RX/ USB3-3 RX PE6 RX	PCIe Lane 6 Receive +
PCIe Lane 6 Transmit -	PE6-TX#/ USB3-3-TX#/ USBC2-TX#	84	83	USBC2 RX#/ USB3-3 RX#/ PE6 RX#	PCIe Lane 6 Receive -
Ground	GND	86	85	GND	Ground
PCIe Lane 7 Transmit +	PE7-TX/ USB3-2-TX	88	87	USB3-2 RX/ PE7 RX	PCIe Lane 7 Receive +
PCIe Lane 7 Transmit -	PE7-TX#/ USB3-2-TX#	90	89	USB3 -2 RX#/ PE7 RX#	PCIe Lane 7 Receive -
USB 2.0 Channel 9 +	USB2-2 (GND)	92	91	USB2-1 (GND)	USB 2.0 Channel 10 +
PCIe Lane 8 Transmit +	PECLK7 (GND)	94	93	PECLK8 (GND)	PCIe Lane 8 Clock +
PCIe Lane 8 Transmit -	PECLK7# (GND)	96	95	PECLK8# (GND)	PCIe Clock Lane 8 -
USB 2.0 Channel 9 -	USB2-2# (GND)	98	97	USB2-1# (GND)	USB 2.0 Channel 10 -
PCIe Lane 8 Transmit +	PE8-TX/ USB3-1-TX	100	99	USB3-1 RX/ PE8 RX	PCIe Lane 8 Receive +
PCIe Lane 8 Transmit -	PE8-TX#/ USB3-1-TX#	102	101	USB3-1 RX#/ PE8 RX#	PCIe Lane 8 Receive -
Ground	GND	104	103	GND	Ground
<b>KEY</b>					
SATA GP1	SATAGP1	106	105	SATAGP2/ (not led out)	SATA GP 2
(not led out)	SATAGP3/ USBC-CC1	108	107	USB-CC2/ SATAGP4/	(not led out)
TwinCAT LED Red	TCLEDR	110	109	TCLEDG	TwinCAT LED Green
TwinCAT LED Blue	TCLEDB	112	111	GPIO8	(not led out)
SATA LED active low	SATA-LED	114	113	USBPWREN	USB Power Enable
RTC Battery	BATT	116	115	PWRFAIL	SUSV



Pin assignment of BeaCon140 connector:					
Description	Signal	Pin		Signal	Description
Power Management Event active low	PME#	118	117	PWRGOOD	Power good
Power button active low	PWRBTN#	120	119	MRST#	Reset button active low
PSON	PSON	122	121	ATXPWRGD	ATX Power good
Ground	GND	124	123	GND	Ground
DisplayPort - / HDMID	DP#/DVI	126	125	DDCC/DPAUX	DDC Clock DisplayPort Aux +/
DisplayPort Hot Plug Detect	DPHPD	128	127	DDCD/DPAUX#	DDC Data DisplayPort Aux -
Ground	GND	130	129	GND	Ground
DisplayPort Lane 0 +	DPL0	132	131	DPL1	DisplayPort Lane 1+
DisplayPort Lane 0 -	DPL0#	134	133	DPL1#	DisplayPort Lane 1 -
Ground	GND	136	135	GND	Ground
DisplayPort Lane 2+	DPL2	138	137	DPL3	DisplayPort 3 +
DisplayPort Lane 2 -	DPL2#	140	139	DPL3#	DisplayPort 3 -

## 7.4 Internal: FAN

The module has two 4-pin fan connections. This enables fans with a supply voltage of 12 V to be connected directly to the module. A signal is also available for monitoring the fan speed.

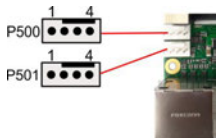

Fig. 10: CB6467 fan cut-out

Pin assignment of fan connector:		
Pin	Signal	Description
1	GND	Ground
2	12 V	Supply voltage 12 V regulated
3	TACHO	Speed monitoring
4	PWM	Speed control

## 7.5 Internal: Battery

The board is delivered with a CR2032 battery holder (Renata VBH2032-1) including a 3 V battery.



### UL conformity

All technical measures for UL conformity are already integrated on the board.

Accordingly, no additional actions are necessary for the connection of an RTC battery. The battery must be connected directly.



BT1200

Fig. 11: CB6467 BAT



### Synchronism of the RTC

The quartz of the RTC reacts to temperature fluctuations. Therefore, correct synchronism of the RTC is possible only with suitable and sufficient cooling!

## 8 LEDs

### 8.1 LED: Power controller

The RGB LED indicates status messages of the power controller by means of colors and flashing intervals.

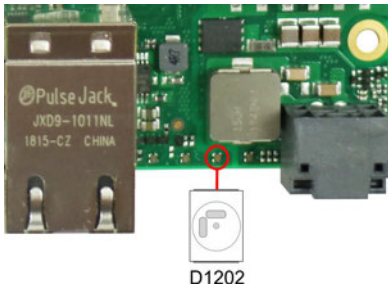

Fig. 12: CB6467 Power LED

Color	Interval	Meaning
None	Steadily lit	System in error state
White	Steadily lit	Power fail
Cyan	Steadily lit	Reserved
Magenta	Steadily lit	S UPS active (if existent)
Blue	Steadily lit	Reserved
Yellow	Steadily lit	S5 state
Green	Steadily lit	S0 state
Red	Steadily lit	Reset/Start
Green/yellow	Flashing	Bootloader running without error
Red/yellow	Flashing	Bootloader is starting (start sequence is being run through)
Yellow	Flashing (6 s)	S4 state
Yellow	Flashing (3 s)	S3 state
Magenta	Flashing (0.5 s)	S UPS capacitance test (if S UPS exists)
Red/magenta	Flashing	Checksum error during the I2C transmission in the bootloader

A steadily lit red LED can indicate a hardware error.

#### ● Adaptation of the status code

**i** It is possible to adapt the status codes (e.g. as TwinCAT LED). To do this, the system colors can be changed with the aid of an SMB command. This change remains in force until the next restart or reset. A change of the default colors is indicated by the additional flashing of the white LED.

## 8.2 LED: SATA

The RGB LED indicates the hard disk activity.

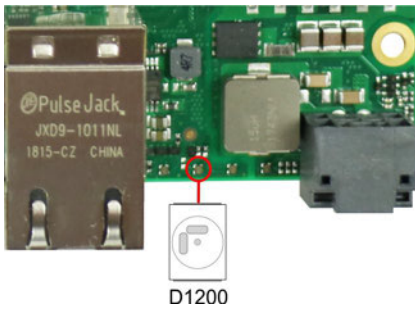

Fig. 13: CB6467 SATA LED

Color	Interval	Meaning
Red	Flashing	Activity (access)

### 8.3 LED: TwinCAT

The RGB LED indicates status messages for TwinCAT by means of colors and flashing intervals.

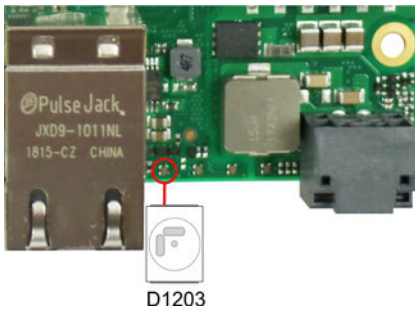

Fig. 14: CB6467 TC LED

Color	Interval	Meaning
Green	Steadily lit	TwinCAT Run Mode
Blue	Steadily lit	TwinCAT Config Mode
Red	Steadily lit	TwinCAT Stop

**● Adaptation of the status codes**

**i** It is possible to adapt the status codes (e.g. as TwinCAT LED). To do this, the system colors can be changed with the aid of an SMB command. This change remains in force until the next restart or reset. A change of the default colors is indicated by the additional flashing of the white LED.

## 8.4 LED: UPS-OCT

The RGB LED indicates the transmission quality of the UPS-OCT signals by means of colors and flashing intervals.

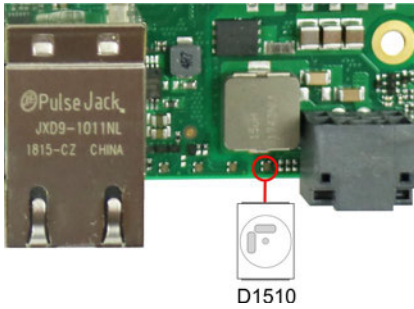

Fig. 15: CB6467 OCT LED

Color	Interval	Meaning
None	Steadily lit	No UPS-OCT connected
Blue	Flashing	Bootloader active
Yellow	Steadily lit	Moderate signal quality
Green	Steadily lit	Good signal quality
Red	Steadily lit	Poor signal quality

If the LED is not lit, no UPS-OCT is connected.

### ● Adaptation of the status codes

**i** It is possible to adapt the status codes (e.g. as UPS-OCT-LED). To do this, the system colors can be changed with the aid of an SMB command. This change remains in force until the next restart or reset.

## 9 BIOS

### 9.1 Using the setup

Within the individual setup pages the last saved settings can be restored can at any time with F2 ("Previous Values"). Use F3 ("Optimized Defaults") to load the factory defaults. Use F2/F3 to load the complete set of settings and F4 to save them ("Save & Reset").

A "▶" sign in front of the menu item indicates that a submenu is available. Use the arrow keys to navigate between menu items. Use the Enter key to select menu items and call submenus or selection dialogs.

For each setup option a help text is displayed at the top right, which in many cases contains useful information about the option and permitted values, etc.

---

#### **Note on Setup Documentation**

**i** The BIOS is regularly updated so that the available setup options can change at any time without notice. This may result in differences between the options actually available and those described below. It should also be noted that the settings shown in the setup menus below are not necessarily the recommended or default settings. Which settings must be selected depends on the application scenario in which the board is operated.

---

## 9.2 Main

Aptio Setup Utility - Copyright (C) 2020 American Megatrends, Inc.

**Main**   Advanced   Chipset   Security   Boot   Save & Exit

<pre> Board Information Board                CB6467 Revision             2 Bios Version         0.13  Processor Information Name                 CoffeeLake DT Type                 Intel(R) Celeron(R)                     G4900 CPU @ 3.10GHz Speed                3100 MHz ID                   0x906ED Stepping             B0 Number of Processors 2Core(s) / 2Thread(s) Microcode Revision   C6 GT Info              GT1 (0x3E93)  IGFX VBIOS Version   N/A IGFX GOP Version     9.0.1105 Memory RC Version    0.7.1.112 Total Memory         4096 MB Memory Frequency     2400 MHz  PCH Information Name                 CNL PCH-H Stepping             B0  ME FW Version        0.0.0.0  System Date          [Tue 11/01/2020] System Time          [04:00:35]                 </pre>	<p>Set the Date. Use Tab to switch between Date elements.                  Default Ranges:                  Year: 2005-2099                  Months: 1-12                  Days: dependent on month</p> <hr/> <p>←: Select Screen                  ↑↓: Select Item                  Enter: Select                  +/-: Change Opt.                  F1: General Help                  F2: Previous Values                  F3: Optimized Defaults                  F4: Save &amp; Reset                  ESC: Exit</p>
---	---

Version 2.20.1275. Copyright (C) 2020 American Megatrends, Inc.

BIOS-Entry	Options
Board*	None
Revision	None
Bios Version	None
Processor Information	
Name	None
Type	None
Speed	None
ID	None
Stepping	None
Number of Processors	None
Microcode Revision	None
GT Info	None
IGFX VBIOS Version	None
IGFX GOP Version	None
Memory RC Version	None
Total Memory	None
Memory Frequency	None
System Date	Here the system date can be changed.
System Time	Here the system time can be changed.

**NOTE**

**BIOS Version**  
 BIOS description according to example of Intel® Celeron® CPU G4900 / Coffee Lake.



### 9.3 Advanced Menu

Aptio Setup Utility - Copyright (C) 2020 American Megatrends, Inc.  
Main **Advanced** Chipset Security Boot Save & Exit

<pre> PowerSupply Type           [ATX] SoftOff on Overheat       [Disabled] Show Postcode on screen   [Disabled] &gt; RC ACPI Settings &gt; CPU Configuration &gt; Trusted Computing &gt; ACPI Settings &gt; Hardware Monitor &gt; AMI Graphic Output Protocol Policy &gt; PCI Subsystem Settings &gt; USB Configuration &gt; NVMe Configuration &gt; Power Controller Options &gt; BAseCon* Configuration &gt; SATA And RST Configuration   AMT Configuration &gt; Tls Auth Configuration &gt; Network Stack Configuration &gt; Intel(R)Rapid Storage Technology  &gt; Driver Health                 </pre>	<p>Select the Type of the Power Supply: AT/ATX</p> <hr/> <p>←: Select Screen  ↑↓: Select Item  Enter: Select  +/-: Change Opt.  F1: General Help  F2: Previous Values  F3: Optimized Defaults  F4: Save &amp; Reset  ESC: Exit</p>
--	--

Version 2.20.1275. Copyright (C) 2020 American Megatrends, Inc.

BIOS-Entry	Options
Power-Supply Type	ATX / AT
SoftOff on Overheat	Disabled / Enabled / Enabled (Emulate PwrBtn)
Show postcode on screen	Disabled / Enabled
RC ACPI Settings	Submenu see: <a href="#">RC ACPI Settings [▶ 42]</a>
CPU Configuration	Submenu see: <a href="#">CPU Configuration [▶ 43]</a>
Trusted Computing	Submenu see: <a href="#">Trusted Computing [▶ 44]</a>
ACPI Settings	Submenu see: <a href="#">ACPI Settings Disabled [▶ 45]</a>
	Submenu see: <a href="#">ACPI Settings Enabled [▶ 44]</a>
Hardware Monitor	Submenu see: <a href="#">Hardware Monitor [▶ 46]</a>
AMI Graphic Output Protocol Policy	Submenu see: <a href="#">AMI Graphic Output Protocol Policy [▶ 47]</a>
PCI Subsystem Settings	Submenu see: <a href="#">PCI Subsystem Settings [▶ 48]</a>
USB Configuration	Submenu see: <a href="#">USB Configuration [▶ 50]</a>
NVME Configuration	Submenu see: <a href="#">NVMe Configuration [▶ 51]</a>
Power Controller Options	Submenu see: <a href="#">Power Controller Options [▶ 52]</a>
BAseCon Configuration	Submenu see: <a href="#">BAseCon* Configuration [▶ 53]</a>
SATA and RST Configuration	Submenu see: <a href="#">SATA And RST Configuration [▶ 54]</a>
AMT Configuration	Submenu see: <a href="#">AMT Configuration [▶ 57]</a>
Tls Auth Configuration	Submenu see: <a href="#">TLs Auth Configuration [▶ 61]</a>
Network Stack Configuration	Submenu see: <a href="#">Network Stack Configuration [▶ 63]</a>
Intel® Rapid Store Technology	Submenu see: <a href="#">Intel Rapid Storage Technology [▶ 64]</a>
Driver Health	Submenu see: <a href="#">Driver Health [▶ 64]</a>

\*Former designation for BEACon140.

### 9.3.1 RC ACPI Settings

Aptio Setup Utility - Copyright (C) 2020 American Megatrends, Inc.

**Advanced**

RC ACPI Settings  PTID Support [Enabled] PECI Access Method [Direct I/O] Native PCIE Enable [Enabled] PUIS Enable [Disabled]  PCI Delay Optimization [Enabled] MSI enabled [Enabled]	PTID Support will be loaded if enabled.  <hr/> ←: Select Screen ↑↓: Select Item Enter: Select +/-: Change Opt. F1: General Help F2: Previous Values F3: Optimized Defaults F4: Save & Reset ESC: Exit
--	---

Version 2.20.1275. Copyright (C) 2020 American Megatrends, Inc.

BIOS-Entry	Options
RC ACPI Settings	
PTID Support	Enabled / Disabled
PECI Access Method	Direct I/O
Native PCIE Enable	Enabled / Disabled
PUIS Enable	None
MSI enabled	Enabled / Disabled

### 9.3.2 CPU Configuration

Aptio Setup Utility - Copyright (C) 2020 American Megatrends, Inc.

**Advanced**

CPU Configuration		Enable/Disable Software Guard Extensions (SGX)
Type	Intel(R) Celeron(R) G4900 CPU @ 3.10GHz	→: Select Screen ↑↓: Select Item Enter: Select +/-: Change Opt. F1: General Help F2: Previous Values F3: Optimized Defaults F4: Save & Reset ESC: Exit
ID	0x906EB	
Speed	3100 MHz	
L1 Data Cache	32 KB x 2	
L1 Instruction Cache	32 KB x 2	
L2 Cache	256 KB x 2	
L3 Cache	2 MB	
L4 Cache	N/A	
VMX	Supported	
SMX/TXT	Not Supported	
Software Guard Extensions (SGX)	[Disabled]	
Hardware Prefetcher	[Enabled]	
Adjacent Cache Line Prefetch	[Enabled]	
Intel (VMX) Virtualization Technology	[Enabled]	
PECI	[Enabled]	
Active Processor Cores	[All]	
AES	[Enabled]	

Version 2.20.1275. Copyright (C) 2020 American Megatrends, Inc.

BIOS-Entry	Options
<b>CPU Configuration</b>	
Type	None
ID	None
Speed	None
L1 Data Cache	None
L1 Instruction Cache	None
L2 Cache	None
L3 Cache	None
L4 Cache	None
VMX	None
SMX/TXT	None
Software Guard Extensions (SGX)	Disabled / Enabled / Software Controlled
Hardware Prefetcher	Enabled / Disabled
Adjacent Cache Line Prefetch	Enabled / Disabled
Intel (VMX) Virtualization Technology	Enabled / Disabled
PECI	Enabled / Disabled
Active Processor Cores	All / 1
AES	Enabled / Disabled

### 9.3.3 Trusted Computing

Aptio Setup Utility - Copyright (C) 2020 American Megatrends, Inc.

**Advanced**

Configuration Security Device Support [Disable] NO Security Device Found	Enables or Disables BIOS support for security device. O.S. will not show Security Device. TCG EFI protocol and INT1A interface will not be available.
←>: Select Screen ↑↓: Select Item Enter: Select +/-: Change Opt. F1: General Help F2: Previous Values F3: Optimized Defaults F4: Save & Reset ESC: Exit	

Version 2.20.1275. Copyright (C) 2020 American Megatrends, Inc.

BIOS-Entry	Options
Configuration	
Security Device Support	Enable / Disable
No Security Device Found	None

### 9.3.4 ACPI Settings Enabled

Aptio Setup Utility - Copyright (C) 2020 American Megatrends, Inc.

**Advanced**

ACPI Settings Enable ACPI Auto Configuration [Enabled]	Enables or Disables BIOS ACPI Auto Configuration.
←: Select Screen ↑↓: Select Item Enter: Select +/-: Change Opt. F1: General Help F2: Previous Values F3: Optimized Defaults F4: Save & Reset ESC: Exit	

Version 2.20.1275. Copyright (C) 2020 American Megatrends, Inc.

BIOS-Entry	Options
ACPI Settings	
Enable ACPI Auto Configuration	Enabled / Disabled

### 9.3.5 ACPI Settings Disabled

Aptio Setup Utility - Copyright (C) 2020 American Megatrends, Inc.

**Advanced**

<p>ACPI Settings</p> <p>Enable ACPI Auto Configuration            [Disabled]</p> <p>Enable Hibernation                            [Enabled]</p> <p>Lock Legacy Resources                        [Disabled]</p>	<p>Enables or Disables BIOS ACPI Auto Configuration.</p>   <p>→: Select Screen            ↑↓: Select Item            Enter: Select            +/-: Change Opt.            F1: General Help            F2: Previous Values            F3: Optimized Defaults            F4: Save &amp; Reset            ESC: Exit</p>
--	---

Version 2.20.1275. Copyright (C) 2020 American Megatrends, Inc.

BIOS-Entry	Options
ACPI Settings	
Enable ACPI Auto Configuration	Enabled / Disabled
Enable Hibernation	Disabled / Enabled
Lock Legacy Resources	Disabled / Enabled

### 9.3.6 Hardware Monitor

Aptio Setup Utility - Copyright (C) 2020 American Megatrends, Inc.

**Advanced**

<p>Pc Health Status</p> <pre> CPU dig.           : +38 'C 1.05V              : +1.02 V VCCCORE           : +0.89 V 5V                 : +5.04 V 12V                : +12.51 V Memory VDD        : +1.23 V 3.3V               : +3.30 V FAN 1              : 1142 RPM FAN 2              : N/A MB Temp            : +29 'C Memory Temp       : +29 'C PwrCtrlTemp       : +37 'C PwrCtrlVCC        : +5.10 V  Smart Fan          [Enabled]                 </pre>	<p>Enable or Disable smart fan control</p> <hr/> <p>←: Select Screen  ↑↓: Select Item  Enter: Select  +/-: Change Opt.  F1: General Help  F2: Previous Values  F3: Optimized Defaults  F4: Save &amp; Reset  ESC: Exit</p>
--	--

Version 2.20.1275. Copyright (C) 2020 American Megatrends, Inc.

BIOS-Entry	Options
PC Health Status	Keine
Smart Fan	Enabled / Disabled

### 9.3.7 AMI Graphic Output Protocol Policy

Aptio Setup Utility - Copyright (C) 2020 American Megatrends, Inc.

**Advanced**

Intel(R) Graphics Controller Intel(R) GOP Driver [9.0.1105] Output Select [HDMI2]	Output Interface  ←: Select Screen ↑↓: Select Item Enter: Select +/-: Change Opt. F1: General Help F2: Previous Values F3: Optimized Defaults F4: Save & Reset ESC: Exit
---	--

Version 2.20.1275. Copyright (C) 2020 American Megatrends, Inc.

BIOS-Entry	Options
Intel® Graphics Controller Intel® GOP Driver [9.0.1105]	
Output Select	None

### 9.3.8 PCI Subsystem Settings

Aptio Setup Utility - Copyright (C) 2020 American Megatrends, Inc.

**Advanced**

<pre> PCI Bus Driver Version           A5.01.17  PCI Devices Common Settings: PCI Latency Timer                [32 PCI Bus Clocks] PCI-X Latency Timer              [64 PCI Bus Clocks] VGA Palette Snoop                [Disabled] PERR# Generation                 [Disabled] SERR# Generation                 [Disabled] BME DMA Mitigation               [Disabled]  &gt; PCI Hot-Plug Settings                 </pre>	<p>Value to be programmed into PCI Latency Timer Register.</p> <hr/> <pre> ←: Select Screen ↑↓: Select Item Enter: Select +/-: Change Opt. F1: General Help F2: Previous Values F3: Optimized Defaults F4: Save &amp; Reset ESC: Exit                 </pre>
--	--

Version 2.20.1275. Copyright (C) 2020 American Megatrends, Inc.

BIOS-Entry	Options
PCI Bus Driver Version	None
PCI Device Common Settings:	
PCI Latency Timer	32 / 64 / 96 / 128 / 160 / 192 / 224 / 248 / PCI Bus Clocks
PCI-X Latency Timer	32 / 64 / 96 / 128 / 160 / 192 / 224 / 248 / PCI Bus Clocks
VGA Palette Snoop	Disabled / Enabled
PERR# Generation	Disabled / Enabled
SERR# Generation	Disabled / Enabled
Above 4G Decoding	Disabled / Enabled
PCI Hot-Plug Settings	Submenu see: <a href="#">PCI Hot-Plug Settings [▶ 49]</a>



### 9.3.8.1 PCI Hot-Plug Settings

Aptio Setup Utility - Copyright (C) 2020 American Megatrends, Inc.

**Advanced**

<p>PCI Hot-Plug Settings</p> <p>BIOS Hot-Plug Support [Enabled]</p> <p>PCI Buses Padding [1]</p> <p>I/O Resources Padding [4 K]</p> <p>MMIO 32 bit Resources Padding [16 M]</p> <p>PFMMIO 32 bit Resources Padding [16 M]</p>	<p>If ENABLED allows BIOS build in Hot-Pug support. Use this feature if OS does not support PCI Express and SHPC hot-plug natively.</p> <hr/> <p>→: Select Screen              ↑↓: Select Item              Enter: Select              +/-: Change Opt.              F1: General Help              F2: Previous Values              F3: Optimized Defaults              F4: Save &amp; Reset              ESC: Exit</p>
---	---

Version 2.20.1275. Copyright (C) 2020 American Megatrends, Inc.

BIOS-Entry	Options
PCI Hot-Plug Settings	
BIOS Hot-Plug Support	Enabled / Disabled
PCI Buses Padding	Disabled / 1 / 2 / 3 / 4 / 5
I/O Resources Padding	Disabled / 4 K / 8 K / 16 K / 32 K
MMIO 32 bit Resources Padding	Disabled / 1 M / 2 M / 4 M / 8 M / 16 M / 32 M / 64 M / 128 M
PFMMIO 32 bit Resources Padding	Disabled / 1 M / 2 M / 4 M / 8 M / 16 M / 32 M / 64 M / 128 M



### 9.3.10 NVMe Configuration

Aptio Setup Utility - Copyright (C) 2020 American Megatrends, Inc.

**Advanced**

NVMe controller and Drive information  No NVME Device Found	←: Select Screen ↑↓: Select Item Enter: Select +/-: Change Opt. F1: General Help F2: Previous Values F3: Optimized Defaults F4: Save & Reset ESC: Exit
---	--

Version 2.20.1275. Copyright (C) 2020 American Megatrends, Inc.

BIOS-Entry	Options
NVMe controller and Drive Information	
No NVME Device Found	None

<b>NOTE</b>
<b>NVMe Raid 0/1 is not supported.</b>

### 9.3.11 Power Controller Options

Aptio Setup Utility - Copyright (C) 2020 American Megatrends, Inc.

**Advanced**

<pre> Bootloader Version          1.01-37 Firmware Version           1.02-28 Mainboard Serial No        ..... Mainboard Prod. Date (Week.Year) 03.20 Mainboard BootCount       11129 Mainboard Operation Time   1923min (32h) Voltage (Min/Max)          5.00V / 5.10V Temperature (Min/Max)      23'C /81'C  ext. USB-Port Voltage      [Off in S3-5] WatchDogTimer Mode        [Normal Mode] WDT OSBoot timeout        [Disabled]  OCT-Transmitter Revision   1.39 No OCT-Receiver (or OCTUPS) found No OCT-UPS detected  USB disabled or USB-cable not connected UPS-ACPI-Device            [Disabled]                 </pre>	<p>Select Power line for external USB devices, if powered-down</p> <hr/> <p>←: Select Screen                  ↑↓: Select Item                  Enter: Select                  +/-: Change Opt.                  F1: General Help                  F2: Previous Values                  F3: Optimized Defaults                  F4: Save &amp; Reset                  ESC: Exit</p>
--	--

Version 2.20.1275. Copyright (C) 2020 American Megatrends, Inc.

BIOS-Entry	Options
Bootloader Version	None
Firmware Version	None
Mainboard Serial No	None
Mainboard Prod. Date (Week.Year)	None
Mainboard BootCount	None
Mainboard Operation Time	None
Voltage /Min/Max)	None
Temperature (Min/Max)	None
ext. USB-Port Voltage	Off in S3-5 / by SCVV
WatchDogTimer Mode	Normal Mode / Compatibility Mode
WDT OSBoot Timeout	Disabled / 45 / 60 / ... / 255 Seconds
OCT-Transmitter Revision	None
No OCT-Receiver (or OCT-UPS) found	None
No OCT-UPS detected	None
OCT-UPS CU8130-240 SN:\$BTN	None
USB disabled or USB-cable not connected	None
UPS-ACPI-Device	Disabled / Prefer OCT / Prefer USB / Use OCT / Use USB

### 9.3.12 BAsCon\* Configuration

Aptio Setup Utility - Copyright (C) 2020 American Megatrends, Inc.

**Advanced**

BAsCon* Configuration  BAsCon 1 serial number                   19391519199991 revision                                   5	Select Power line for external USB devices, if powered-down  ←: Select Screen ↑↓: Select Item Enter: Select +/-: Change Opt. F1: General Help F2: Previous Values F3: Optimized Defaults F4: Save & Reset ESC: Exit
--	--

Version 2.20.1275. Copyright (C) 2020 American Megatrends, Inc.

BIOS-Entry	Options
BAsCon Configuration	
BAsCon 1 serial number revision	None

\*Former designation for the BeaCon140.

### 9.3.13 SATA And RST Configuration

Aptio Setup Utility - Copyright (C) 2020 American Megatrends, Inc.

**Advanced**

SATA And RST Configuration		Enable/Disable SATA Device.
SATA Controller(s)	[Enabled]	←: Select Screen ↑↓: Select Item Enter: Select +/-: Change Opt. F1: General Help F2: Previous Values F3: Optimized Defaults F4: Save & Reset ESC: Exit
SATA Mode Selection	[Intel RST Premium] With Intel Optane System Acceleration]	
SATA Interrupt Selection	[Msix]	
SATA Test Mode	[Disabled]	
RAID Device ID	[Client]	
> Software Feature Mask Configuration		
Aggressive LPM Support	[Disabled]	
Serial ATA Port 0	Empty	
Software Preserve	Unknown	
Port 0	[Enabled]	
Hot Plug	[Disabled]	
Configured as eSATA	Hot Plug supported	
External	[Disabled]	
Spin Up Device	[Disabled]	
SATA Device Type	[Hard Disk Drive]	
SATA Port 0 DevSlp	[Disabled]	
DITO Configuration	[Disabled]	
Serial ATA Port 1	Empty	
Software Preserve	Unknown	
Port 1	[Enabled]	
Hot Plug	[Disabled]	
Configured as eSATA	Hot Plug supported	
External	[Disabled]	
Spin Up Device	[Disabled]	
SATA Device Type	[Hard Disk Drive]	
SATA Port 1 DevSlp	[Disabled]	
DITO Configuration	[Disabled]	
SATA Port 4 (disabled on BAsCon)	Empty	
Software Preserve	Unknown	
Port 4	[Enabled]	
Hot Plug	[Disabled]	
Configured as eSATA	Hot Plug supported	
External	[Disabled]	
Spin Up Device	[Disabled]	
SATA Device Type	[Hard Disk Drive]	
SATA Port 4 DevSlp	[Disabled]	
DITO Configuration	[Disabled]	
SATA Port 5 (disabled on BAsCon)	Empty	
Software Preserve	Unknown	
Port 5	[Enabled]	
Hot Plug	[Disabled]	
Configured as eSATA	Hot Plug supported	
External	[Disabled]	
Spin Up Device	[Disabled]	
SATA Device Type	[Hard Disk Drive]	
SATA Port 5 DevSlp	[Disabled]	
DITO Configuration	[Disabled]	

Version 2.20.1275. Copyright (C) 2020 American Megatrends, Inc.

BIOS-Entry	Options
SATA And RST Configuration	
SATA Controller(s)	Enabled / Disabled
SATA Mode Selection	AHCI / Intel RST Premium With Intel Optane System Acceleration
SATA Test Mode	Disabled / Enabled
Software Feature Mask Configuration	Submenu see: <a href="#">Software Feature Mask Configuration [► 56]</a>
Aggressive LPM Support	Disabled / Enabled
Serial ATA Port 0; 1; 4; 5	None
Software Preserve	None
Port 0	Disabled / Enabled
Hot Plug	Disabled / Enabled
Configured as eSATA	None
External	Disabled / Enabled
Spin Up Device	Disabled / Enabled
SATA Device Type	HDD / SSD
SATA Port 0 DevSlp	Disabled / Enabled
DITO Configuration	Disabled / Enabled

**NOTE**

**Settings at SATA Ports**

The possible settings at the SATA Ports 0;1; 4 and 5 are identical. Therefore they are summarized in this view.

### 9.3.13.1 Software Feature Mask Configuration

Aptio Setup Utility - Copyright (C) 2020 American Megatrends, Inc.

**Advanced**

<p>Software Feature Mask Configuration</p> <p>HDD Unlock [Enabled]                  LED Locate [Enabled]                  RAID0 [Enabled]                  RAID1 [Enabled]                  RAID10 [Enabled]                  RAID5 [Enabled]                  Intel Rapid Recovery Technology [Enabled]                  OROM UI and BANNER [Enabled]                  IRRT Only on eSATA [Enabled]                  Smart Response Technology [Enabled]                  OROM UI Normal Delay [2 secs]                  RST Force Form [Disabled]                  System Acceleration with Intel(R) [Enabled]                  Optane(TM) Memory                  CPU Attached Storage [Enabled]</p>	<p>If enabled, indicates that the HDD password unlock in the OS is enabled.</p>           <p>→: Select Screen                  ↑↓: Select Item                  Enter: Select                  +/-: Change Opt.                  F1: General Help                  F2: Previous Values                  F3: Optimized Defaults                  F4: Save &amp; Reset                  ESC: Exit</p>
---	--

Version 2.20.1275. Copyright (C) 2020 American Megatrends, Inc.

BIOS-Entry	Options
<b>Software Feature Mask Configuration</b>	
HDD Unlock	Enabled / Disabled
LED Locate	Enabled / Disabled
RAID0	Enabled / Disabled
RAID1	Enabled / Disabled
RAID10	Enabled / Disabled
RAID5	Enabled / Disabled
Intel Rapid Recovery Technology	Enabled / Disabled
OROM UI and BANNER	Enabled / Disabled
IRRT Only on eSATA	Enabled / Disabled
Smart Response Technology	Enabled / Disabled
OROM UI Normal Delay	2 / 4 / 6 / 8 secs
RST Force Form	Disable / Enabled
System Acceleration with Intel® Optane™ Memory	Enabled / Disabled
CPU Attached Storage	Enabled / Disabled



### 9.3.14 AMT Configuration

Aptio Setup Utility - Copyright (C) 2020 American Megatrends, Inc.

**Advanced**

ASF support [Enabled]  USB Provisioning of AMT [Disabled] > CIRA Configuration > ASF Configuration > Secure Erase Configuration > OEM Flags Settings > MEBx Resolution Settings  Headlessmode [Disabled]	Enable/Disable Alert Standard Format support.	←: Select Screen ↑↓: Select Item Enter: Select +/-: Change Opt. F1: General Help F2: Previous Values F3: Optimized Defaults F4: Save & Reset ESC: Exit
---	---	--

Version 2.20.1275. Copyright (C) 2020 American Megatrends, Inc.

BIOS-Entry	Options
ASF Support	Disabled / Enabled
USB Provisioning of AMT	Disabled / Enabled
CIRA Configuration	Submenu see: <a href="#">CIRA Configuration [▶ 58]</a>
ASF Configuration	Submenu see: <a href="#">ASF Configuration [▶ 59]</a>
Secure Erase Configuration	Submenu see: <a href="#">Secure Erase Configuration [▶ 59]</a>
OEM Flags Settings	Submenu see: <a href="#">OEM Flags Settings [▶ 60]</a>
MEBx Resolution Settings	Submenu see: <a href="#">MEBx Resolution Settings [▶ 61]</a>
Headlessmode	Diabled / Enabled

### 9.3.14.1 CIRA Configuration

Aptio Setup Utility - Copyright (C) 2020 American Megatrends, Inc.

**Advanced**

Activate Remote Assistance Process    [Disabled] CIRA Timeout                                0	Trigger CIRA boot Note: Network Access must be activated first from MEBx Setup.
←: Select Screen ↑↓: Select Item Enter: Select +/-: Change Opt. F1: General Help F2: Previous Values F3: Optimized Defaults F4: Save & Reset ESC: Exit	

Version 2.20.1275. Copyright (C) 2020 American Megatrends, Inc.

BIOS-Entry	Options
Activate Remote Assistance Process	Disabled / Enabled
CIRA Timeout	None

### 9.3.14.2 ASF Configuration

Aptio Setup Utility - Copyright (C) 2020 American Megatrends, Inc.

**Advanced**

PET Progress [Enabled] WatchDog [Disabled] OS Timer 0 BIOS Timer 0 ASF Sensors Table [Disabled]	Enable/Disable PET Events Progress to receive PET Events.	←: Select Screen ↑↓: Select Item Enter: Select +/-: Change Opt. F1: General Help F2: Previous Values F3: Optimized Defaults F4: Save & Reset ESC: Exit
---	---	--

Version 2.20.1275. Copyright (C) 2020 American Megatrends, Inc.

BIOS-Entry	Options
PET Progress	Disabled / Enabled
WatchDog	Disabled / Enabled
OS Timer	None
BIOS Timer	None
ASF Sensors Table	Disabled / Enabled

### 9.3.14.3 Secure Erase Configuration

Aptio Setup Utility - Copyright (C) 2020 American Megatrends, Inc.

**Advanced**

Secure Erase mode [Simulated] Force Secure Erase [Disabled]	Change Secure Erase module behavior: Simulated: Performs SE flow without erasing SSD Real: Erase SSD.	←: Select Screen ↑↓: Select Item Enter: Select +/-: Change Opt. F1: General Help F2: Previous Values F3: Optimized Defaults F4: Save & Reset ESC: Exit
--	---	--

Version 2.20.1275. Copyright (C) 2020 American Megatrends, Inc.

BIOS-Entry	Options
Secure Erase Mode	Simulated / Real
Force Secure Erase	Disabled / Enabled

### 9.3.14.4 OEM Flags Settings

Aptio Setup Utility - Copyright (C) 2020 American Megatrends, Inc.

**Advanced**

MEBx hotkey Pressed [Disabled] MEBx Selection Screen [Disabled] Hide Unconfigure ME Confirmation Prompt [Disabled] MEBx OEM Debug Menu Enable [Disabled] Unconfigure ME [Disabled]	OEMFLag Bit 1: Enable automatic MEBx hotkey press.
←: Select Screen ↑↓: Select Item Enter: Select +/-: Change Opt. F1: General Help F2: Previous Values F3: Optimized Defaults F4: Save & Reset ESC: Exit	

Version 2.20.1275. Copyright (C) 2020 American Megatrends, Inc.

BIOS-Entry	Options
MEBx hotkey Pressed	Disabled / Enabled
MEBx Selection Screen	Disabled / Enabled
Hide Unconfigure ME Confirmation Prompt	Disabled / Enabled
MEBx OEM Debug Menu Enable	Disabled / Enabled
Unconfigure ME	Disabled / Enabled

### 9.3.14.5 MEBx Resolution Settings

Aptio Setup Utility - Copyright (C) 2020 American Megatrends, Inc.

**Advanced**

Non-UI Mode Resolution [Auto] UI Mode Resolution [Auto] Graphics Mode Resolution [Auto]	Resolution for non-UI text mode.  ←: Select Screen ↑↓: Select Item Enter: Select +/-: Change Opt. F1: General Help F2: Previous Values F3: Optimized Defaults F4: Save & Reset ESC: Exit
---	--

Version 2.20.1275. Copyright (C) 2020 American Megatrends, Inc.

BIOS-Entry	Options
Non-UI Resolution	Auto / 80x25 / 100x31
UI Mode Resolution	Auto / 80x25 / 100x31
Graphics Mode Resolution	Auto / 640x480 / 800x600 / 1024x768

### 9.3.15 Tls Auth Configuration

Aptio Setup Utility - Copyright (C) 2020 American Megatrends, Inc.

**Advanced**

> Server CA Configuration > Client Cert Configuration	Press <Enter> to configure Server CA.  ←: Select Screen ↑↓: Select Item Enter: Select +/-: Change Opt. F1: General Help F2: Previous Values F3: Optimized Defaults F4: Save & Reset ESC: Exit
--	---

Version 2.20.1275. Copyright (C) 2020 American Megatrends, Inc.

BIOS-Entry	Options
Server CA Configuration	Submenu see: <a href="#">Server CA Configuration [▶ 62]</a>
Client Cert Configuration	None

### 9.3.15.1 Server CA Configuration

Aptio Setup Utility - Copyright (C) 2020 American Megatrends, Inc.  
**Advanced**

<pre>&gt; Enroll Cert &gt; Delete Cert</pre>	<pre>Press &lt;Enter&gt; to enroll cert.  ←→: Select Screen ↑↓: Select Item Enter: Select +/-: Change Opt. F1: General Help F2: Previous Values F3: Optimized Defaults F4: Save &amp; Reset ESC: Exit</pre>
--	---

Version 2.20.1275. Copyright (C) 2020 American Megatrends, Inc.

BIOS-Entry	Options
Enroll Cert	Submenu see: <a href="#">Enroll Cert [▶ 62]</a>
Delete Cert	None

#### 9.3.15.1.1 Enroll Cert

Aptio Setup Utility - Copyright (C) 2020 American Megatrends, Inc.  
**Advanced**

<pre>&gt; Enroll Cert Using File   Cert GUID &gt; Commit Changes and Exit &gt; Discard Changes and Exit</pre>	<pre>Enroll Cert Using File  ←→: Select Screen ↑↓: Select Item Enter: Select +/-: Change Opt. F1: General Help F2: Previous Values F3: Optimized Defaults F4: Save &amp; Reset ESC: Exit</pre>
---	--

Version 2.20.1275. Copyright (C) 2020 American Megatrends, Inc.

BIOS-Entry	Options
Enroll Cert Enroll Cert Using File	None
Cert GUID	None
Commit Changes and Exit	None
Discard Changes and Exit	None

### 9.3.16 Network Stack Configuration

Aptio Setup Utility - Copyright (C) 2020 American Megatrends, Inc.

**Advanced**

Network Stack [Disabled]	Enable/Disable UEFI Network Stack
	←: Select Screen ↑↓: Select Item Enter: Select +/-: Change Opt. F1: General Help F2: Previous Values F3: Optimized Defaults F4: Save & Reset ESC: Exit

Version 2.20.1275. Copyright (C) 2020 American Megatrends, Inc.

BIOS-Entry	Options
Network Stack	Disabled / Enabled

NOTE

**Network Stack Enabled**

If Network Stack is „enabled“, further menu items for display and setting of the LAN Controller are shown. To achieve, make a reset.

### 9.3.17 Network Stack Configuration enabled

Aptio Setup Utility - Copyright (C) 2020 American Megatrends, Inc.

**Advanced**

Network Stack [Enabled] Ipv4 PXE Support [Enabled] Ipv4 HTTP Support [Disabled] Ipv6 PXE Support [Disabled] Ipv6 HTTP Support [Disabled] IPSEC Certificate [Enabled] PXE boot wait time 0 Media detect count 1	Enable/Disable UEFI Network Stack
	←: Select Screen ↑↓: Select Item Enter: Select +/-: Change Opt. F1: General Help F2: Previous Values F3: Optimized Defaults F4: Save & Reset ESC: Exit

Version 2.20.1275. Copyright (C) 2020 American Megatrends, Inc.

BIOS-Entry	Options
Network Stack	Disabled / Enabled
Ipv4 PXE Support	Disabled / Enabled
Ipv4 HTTP Support	Disabled / Enabled
Ipv6 PXE Support	Disabled / Enabled
Ipv6 HTTP Support	Disabled / Enabled
IPSEC Certificate	Enabled / Disabled
PXE boot wait time	None
Media detect count	None

NOTE
<p><b>PXE Boot available</b></p> <p>PXE Boot is available if you set Network Stack and Ipv4 PXE support to „Enable“.</p>

### 9.3.18 Intel Rapid Storage Technology

Aptio Setup Utility - Copyright (C) 2020 American Megatrends, Inc.

**Advanced**

Intel (R) RST 17.8.0.4414 RAID Driver  No disks connected to system	←: Select Screen ↑↓: Select Item Enter: Select +/-: Change Opt. F1: General Help F2: Previous Values F3: Optimized Defaults F4: Save & Reset ESC: Exit
---	--

Version 2.20.1275. Copyright (C) 2020 American Megatrends, Inc.

BIOS-Entry	Options
Intel® RST 17.8.0.4414 RAID Driver	
No disks connected to system	None

### 9.3.19 Driver Health

Aptio Setup Utility - Copyright (C) 2020 American Megatrends, Inc.

**Advanced**

> Intel (R) Gigabit 0.0.24                      Healthy	←: Select Screen ↑↓: Select Item Enter: Select +/-: Change Opt. F1: General Help F2: Previous Values F3: Optimized Defaults F4: Save & Reset ESC: Exit
---	--

Version 2.20.1275. Copyright (C) 2020 American Megatrends, Inc.

BIOS-Entry	Options
Intel® Gigabit 0.0.24	None



## 9.4 Chipset

```

Aptio Setup Utility - Copyright (C) 2020 American Megatrends, Inc.
Main Advanced Chipset Security Boot Save & Exit

> System Agent (SA) Configuration
> PCH-IO Configuration

System Agent (SA) Parameters

←→: Select Screen
↑↓: Select Item
Enter: Select
+/-: Change Opt.
F1: General Help
F2: Previous Values
F3: Optimized Defaults
F4: Save & Reset
ESC: Exit

Version 2.20.1275. Copyright (C) 2020 American Megatrends, Inc.
    
```

BIOS-Entry	Options
System Agent (SA) Configuration	Submenu see: <a href="#">System Agent (SA) Configuration [▶ 66]</a>
PCH-IO Configuration	Submenu see: <a href="#">PCH-IO Configuration [▶ 68]</a>

### 9.4.1 System Agent (SA) Configuration

Aptio Setup Utility - Copyright (C) 2020 American Megatrends, Inc.  
Chipset

System Agent (SA) Configuration  SA PCIe Code Version                    7.0.110.64 VT-d    Supported > Graphics Configuration Stop Grant Configuration                [Auto] VT-d    [Enabled] CHAP Device (B0:D7:F0)                 [Disabled] Thermal Device (B0:D4:F0)              [Disabled] GNA Device (B0:D8:F0)                  [Enabled] CRID Support                               [Disabled] Above 4GB MMIO BIOS assignment       [Disabled] X2APIC Opt Out                           [Disabled] IPU Device (B0:D5:F0)                   [Disabled]	Graphics Configuration          ←: Select Screen ↑↓: Select Item Enter: Select +/-: Change Opt. F1: General Help F2: Previous Values F3: Optimized Defaults F4: Save & Reset ESC: Exit
--	--

Version 2.20.1275. Copyright (C) 2020 American Megatrends, Inc.

BIOS-Entry	Options
<b>System Agent (SA) Configuration</b>	
SA PCIe Code Version	None
VT-d	None
Graphics Configuration	Submenu see: <a href="#">Graphics Configuration</a>   <b>67</b>
Stop Grant Configuration	Auto / Manual
VT-d	Enabled / Disabled
CHAP Device (B0:07:F0)	Disabled / Enabled
Thermal Device (B0:D4:F0)	Enabled / Disabled
GNA Device (B0:D8:F0)	Enabled / Disabled
CRID Support	Disabled / Enabled
Above 4GB MMIO BIOS assignment	Disabled / Enabled
X2APIC Opt Out	Disabled / Enabled
IPU Device (B0:D5:F0)	Disabled / Enabled

**9.4.1.1 Graphics Configuration**

Aptio Setup Utility - Copyright (C) 2020 American Megatrends, Inc.  
**Chipset**

<p>Graphics Configuration</p> <p>Graphics Turbo IMON Current            31 Skip Scaning of External Gfx Card    [Disabled]</p> <p>Primary Display                            [Auto]</p> <p>&gt; External Gfx Card Primary Display Configuration</p> <p>Internal Graphics                        [Auto]</p> <p>GTT Size                                    [8MB]</p> <p>Aperture Size                             [256MB]</p> <p>PSMI SUPPORT                            [Disabled]</p> <p>DVMT Pre-Allocated                    [32M]</p> <p>DVMT Total Gfx Mem                    [256M]</p> <p>Intel Graphics Pei Display Peim      [Disabled]</p> <p>VDD Enable                                [Enabled]</p> <p>PM Support                                [Disabled]</p> <p>PAVP Enable                               [Enabled]</p> <p>Cdynmax Clamping Enable              [Enabled]</p> <p>Cd Clock Frequency                     [675 Mhz]</p>	<p>Graphics turbo IMON current values supported (14-31)</p> <hr/> <p>←: Select Screen ↑↓: Select Item Enter: Select +/-: Change Opt. F1: General Help F2: Previous Values F3: Optimized Defaults F4: Save &amp; Reset ESC: Exit</p>
--	---

Version 2.20.1275. Copyright (C) 2020 American Megatrends, Inc.

BIOS-Entry	Options
<b>Graphics Configuration</b>	
Graphics Turbo IMON Current	None
Skip Scaning of External Gfx Card	Disabled / Enabled
Primary Display	Auto / IGFX / PCI / SG
External Gfx Card Primary Display Configuration	None
Internal Graphics	Auto / Disabled / Enabled
GTT Size	2 / 4 / 8 MB
Aperture Size	128 / 256 / 512 / 1024 / 2048 MB
PSMI SUPPORT	Disabled / Enabled
DVMT Pre-Allocated	0M, 32M...60M
DVMT Total Gfx Mem	128M / 256M / MAX
Intel Graphics Pei Display Peim	Disabled / Enabled
VDD Enable	Enabled / Disabled
PM Support	None
PAVP Enable	Enabled / Disabled
Cdynmax Clamping Enable	Enabled / Disabled
Cd Clock Frequency	337.5 / 450 / 540 / 675 Mhz

### 9.4.2 PCH-IO Configuration

Aptio Setup Utility - Copyright (C) 2020 American Megatrends, Inc.  
Chipset

<p>PCH-IO Configuration</p> <p>&gt; PCI Express Configuration &gt; USB Configuration &gt; HD Audio Configuration</p> <p>PCH LAN Controller [Enabled] Wake on LAN Enable [Enabled] Second LAN Controller [Enabled] Third LAN Controller [Enabled] Forth LAN Controller [Enabled] PS_ON Enable [Disabled] M.2-Slot 0 NC-PCIe M.2-Slot 1 Not Present</p> <p>CLKRUN# logic [Enabled] State After G3 [S0 State] Compatible Revision ID [Disabled] Legacy IO Low Latency [Enabled] Enable TCO Timer [Enabled]</p>	<p>PCI Express Configuration settings</p>          <p>→: Select Screen ↑↓: Select Item Enter: Select +/-: Change Opt. F1: General Help F2: Previous Values F3: Optimized Defaults F4: Save &amp; Reset ESC: Exit</p>
---	--

Version 2.20.1275. Copyright (C) 2020 American Megatrends, Inc.

BIOS-Entry	Options
PCH-IO Configuration	
PCI Express Configuration	Submenu see: <a href="#">PCI Express Configuration [▶ 69]</a>
USB Configuration	Submenu see: <a href="#">USB Configuration [▶ 73]</a>
HD Audio Configuration	Submenu see: <a href="#">HD Audio Configuration [▶ 73]</a>
PCH LAN Controller	Enabled / Disabled
Wake on LAN Enable	Enabled / Disabled
Second LAN Controller	Enabled / Disabled
Third LAN Controller	Enabled / Disabled
Forth LAN Controller	Enabled / Disabled
PS_ON Enable	Disabled / Enabled
M.2-Slot 0	None
M.2-Slot 1	None
CLKRUB# logic	Enabled / Disabled
State After G3	S0 State / S5 State
Compatible Revision ID	None
Legacy IO Low Latency	Enabled / Disabled
Enable TCO Timer	Disabled / Enabled

9.4.2.1 PCI Express Configuration

Aptio Setup Utility - Copyright (C) 2020 American Megatrends, Inc.  
Chipset

<p>PCI Express Configuration</p> <p>PCI Express Clock Gating [Disabled]                  PCIE Port assigned to LAN 5                  Peer Memory Write Enable [Disabled]                  Compliance Test Mode [Disabled]                  PCIe-USB Glitch W/A [Disabled]</p> <p>PCIe RP 1 (disabled on BeaCon)                  PCIe RP 2 (disabled on BeaCon)                  PCIe RP 3 (disabled on BeaCon)                  PCIe RP 4 (disabled on BeaCon)                  PCIe Port 5 is assigned to LAN1                  PCIe Root Port 9 (to M.2-Slot0)                  PCIe Root Port 10 (to M.2-Slot0) Shadowed by x2/x4 port                  PCIe Root Port 11 (to M.2-Slot0) Shadowed by x2/x4 port                  PCIe Root Port 12 (to M.2-Slot0) Shadowed by x2/x4 port                  PCIe Root Port 13 (to M.2-Slot1)                  PCIe Root Port 11 (to M.2-Slot0)                  PCIe Root Port 12 (to M.2-Slot0)                  PCIe RP 17 (disabled on BeaCon)                  PCIe RP 18 (disabled on BeaCon)                  PCIe RP 19 (disabled on BeaCon)                  PCIe RP 20 (disabled on BeaCon)</p>	<p>PCI Express Clock Gating                  Enable/Disable for each root port.</p> <hr/> <p>←: Select Screen                  ↑↓: Select Item                  Enter: Select                  +/-: Change Opt.                  F1: General Help                  F2: Previous Values                  F3: Optimized Defaults                  F4: Save &amp; Reset                  ESC: Exit</p>
---	---

Version 2.20.1275. Copyright (C) 2020 American Megatrends, Inc.

BIOS-Entry	Options
PCI Express Configuration	
PCI Express Clock Gating	Disabled / Enabled
PCIE Port assigned to LAN	None
Peer Memory Write Enable	Disabled / Enabled
Compliance Test Mode	Disabled / Enabled
PCIe-USB Glitch W/A	Disabled / Enabled
PCIe RP 1 - 4	Disabled / Enabled
PCIe Root Port 9 (to M.2-Slot0)	Disabled / Enabled
PCIe Root Port 10 (toM.2-Slot0)	None
PCIe Root Port 11 (to M.2-Slot0)	None
PCIe Root Port 12 (to M.2-Slot0)	None
PCIe Root Port 13 (to M.2-Slot1)	Disabled / Enabled
PCIe RP 17 - 20	Disabled / Enabled

### 9.4.2.1.1 PCI Express Root Port 1

Aptio Setup Utility - Copyright (C) 2020 American Megatrends, Inc.  
**Chipset**

<pre> PCI Express Root Port 1           [Enabled] Disable Gen2 P11 Shutdown and L1 [Disabled] Controller Power gating Connection Type                   [Slot] Gen3 Eq Phase3 Method             [Hardware] UPTP                              5 DPTP                              7 ACS                               [Enabled] PTM                               [Enabled] DPC                               [Enabled] EDPC                              [Enabled]   URR                             [Disabled]   FER                             [Disabled]   NFER                            [Disabled]   CER                             [Disabled]   CTO                             [Disabled]   SEFE                            [Disabled]   SENFE                           [Disabled]   SECE                            [Disabled]   PME SCI                         [Enabled]   Hot Plug                        [Disabled]   Advanced Error Reporting        [Enabled] PCIe Speed                        [Auto]   Transmitter Half Swing         [Disabled] Detect Timeout                    0 Extra Bus Reserved                0 Reserved Memory                  10 Reserved I/O                     0  PCH PCIe LTR Congguration LTR                               [Enabled]   Snoop Latency Override         [Auto]   Non Snoop Latency Override     [Auto]   Force LTR Override             [Disabled]  LTR Lock                          [Disabled] &gt;Extra Options         </pre>	<p>Control the PCI Express Root Port.</p> <hr/> <pre> ←→: Select Screen ↑↓: Select Item Enter: Select +/-: Change Opt. F1: General Help F2: Previous Values F3: Optimized Defaults F4: Save &amp; Reset ESC: Exit         </pre>
--	--

Version 2.20.1275. Copyright (C) 2020 American Megatrends, Inc.

BIOS-Entry	Options
PCI Express Root Port 1	Disabled / Enabled
Disable Gen2 PII Shutdown and L1 and Controller Power gating	Disabled / Enabled
Connection Type	Built-in / Slot
Gen3 Eq Phase3 Method	Hardware / Static Coeff.
UPTP	None
DPTP	None
ACS	Enabled / Disabled
PTM	Enabled / Disabled
DPC	Enabled / Disabled
EDPC	Enabled / Disabled
URR	Disabled / Enabled
FER	Disabled / Enabled
NFER	Disabled / Enabled
CER	Disabled / Enabled
CTO	Disabled / Enabled
SEFE	Disabled / Enabled
SENF	Disabled / Enabled
PME SCI	Enabled / Disabled
Hot Plug	Disabled / Enabled
Advanced Error Reporting	Enabled / Disabled
PCIe Speed	Auto / Gen1 / Gen2 / Gen3
Transmitter Half Swing	Disabled / Enabled
Detect Timeout	None
Extra Bus Reserved	None
Reserved Memory	None
Reserved I/O	None
PCH PCIe LTR Configuration	
LTR	Enabled / Disabled
Snoop Latency Override	Disbaled / Manual / Auto
Non Snoop Latency Override	Disbaled / Manual / Auto
Force LTR Override	Disabled / Enabled
LTR Lock	
LTR Lock	Disabled / Enabled
Extra Options	Submenu see: <a href="#">Extra Options</a> [▶ 72]

**NOTE**

**PCI Express Configuration**

The BIOS-entries and the optiones at the ports 1 – 4, 9, 13 und 17 - 20 are identical. Port 1 is shown as example.

**Extra Options**

Aptio Setup Utility - Copyright (C) 2020 American Megatrends, Inc.  
**Chipset**

Detect Non-Compliance Device            [Disabled] Prefetchable Memory                        10 Reserved Memory Alignment                1 Prefetchable Memory Alignment            1	Detect Non-Compliance PCI Express Device. If enable, it will take more time at POST time. <hr/> ←: Select Screen ↑↓: Select Item Enter: Select +/-: Change Opt. F1: General Help F2: Previous Values F3: Optimized Defaults F4: Save & Reset ESC: Exit
---	---

Version 2.20.1275. Copyright (C) 2020 American Megatrends, Inc.

BIOS-Entry	Options
Detect Non-Compliance Device	Disabled / Enabled
Prefetchable Memory	None
Reserved Memory Alignment	None
Preftechable Memory Alignment	None



### 9.4.2.2 USB Configuration

Aptio Setup Utility - Copyright (C) 2020 American Megatrends, Inc.	
Chipset	
USB Configuration	Option to enable Compliance Mode. Default is to disable Compliance Mode. Change to enabled for Compliance Mode testing.
XHCI Compliance Mode [Disabled]	
USB Port Disable Override [Disable Link]	
	→: Select Screen ↑↓: Select Item Enter: Select +/-: Change Opt. F1: General Help F2: Previous Values F3: Optimized Defaults F4: Save & Reset ESC: Exit
Version 2.20.1275. Copyright (C) 2020 American Megatrends, Inc.	

BIOS-Entry	Options
USB Configuration	
XHCI Compliance Mode	Disabled / Enabled
USB Port Disable Override	Disable Link / Select Per-Pin

### 9.4.2.3 HD Audio Configuration

Aptio Setup Utility - Copyright (C) 2020 American Megatrends, Inc.	
Chipset	
HD Audio Subsystem Configuration Settings	Control Detection of the HD-Audio device. Disabled = HDA will be unconditionally disabled. Enabled = HDA will be unconditionally enabled.
HD Audio [Enabled]	
	→: Select Screen ↑↓: Select Item Enter: Select +/-: Change Opt. F1: General Help F2: Previous Values F3: Optimized Defaults F4: Save & Reset ESC: Exit
Version 2.20.1275. Copyright (C) 2020 American Megatrends, Inc.	

BIOS-Entry	Options
HD Audio Subsystem Configuration Settings	
HD Audio	Enabled / Disabled

## 9.5 Security

```

Aptio Setup Utility - Copyright (C) 2020 American Megatrends, Inc.
Main Advanced Chipset Security Boot Save & Exit

Password Description                               Set Administrator Password

Minimum length                                     3
Maximum length                                     20

Administrator Password

User Mode available                               [Enabled]

> Secure Boot

                                        ←: Select Screen
                                        ↑↓: Select Item
                                        Enter: Select
                                        +/-: Change Opt.
                                        F1: General Help
                                        F2: Previous Values
                                        F3: Optimized Defaults
                                        F4: Save & Reset
                                        ESC: Exit

Version 2.20.1275. Copyright (C) 2020 American Megatrends, Inc.
    
```

BIOS-Entry	Options
Password Description	
Minimum length	None
Maximum length	None
Administrator Password	Set here an administrator-password.
User Mode available	Enabled / Disabled
Secure Boot	Submenu see: <a href="#">Secure Boot [▶ 75]</a>

### 9.5.1 Secure Boot

Aptio Setup Utility - Copyright (C) 2020 American Megatrends, Inc.  
**Security**

System Mode  Secure Boot  Secure Boot Mode > Restore Factory Keys > Reset To Setup Mode  > Key Management	User  [Disabled] Not Active  [Custom]	Secure Boot feature is Active if Secure Boot is Enabled, Platform Key(PK) is enrolled and the System is in User mode. The mode change requires platform reset   ←: Select Screen ↑↓: Select Item Enter: Select +/-: Change Opt. F1: General Help F2: Previous Values F3: Optimized Defaults F4: Save & Reset ESC: Exit
---	--	---

Version 2.20.1275. Copyright (C) 2020 American Megatrends, Inc.

BIOS-Entry	Options
System Mode	None
Secure Boot	Disabled / Enabled Not Active
Secure Boot Mode	Custom / Standard
Restore Factory Keys	Submenu see: <a href="#">Restore Factory Keys [▶ 76]</a>
Reset To Setup Mode	Submenu see: <a href="#">Reset To Setup Mode [▶ 77]</a>
Key Management	Untermenü see: <a href="#">Key Management [▶ 78]</a>

### 9.5.1.1 Restore Factory Keys

Aptio Setup Utility - Copyright (C) 2020 American Megatrends, Inc.  
**Security**

System Mode Secure Boot Secure Boot Mode > Restore Factory Keys > Reset To Setup Mode > Key Management	User [Disabled] Not Active [Custom]	Force System to User Mode. Install factory default Secure Boot key databases  elect Screen elect Item : Select Change Opt. F1: General Help F2: Previous Values F3: Optimized Defaults F4: Save & Reset ESC: Exit
---	--	---

Install factory defaults

Press 'Yes' to proceed 'No' to cancel

---

Yes No

Version 2.20.1275. Copyright (C) 2020 American Megatrends, Inc.

BIOS-Entry	Options
System Mode	None
Secure Boot	Disabled / Enabled
Secure Boot Mode	Custom / Standard
Restore Factory Keys	Install factory defaults, see box

**9.5.1.2 Reset To Setup Mode**

Aptio Setup Utility - Copyright (C) 2020 American Megatrends, Inc.  
**Security**

System Mode  Secure Boot  Secure Boot Mode > Restore Factory Keys > Reset To Setup Mode  > Key Management	User  [Disabled] Not Active  [Custom]	Delete all Secure Boot key databases from NVRAM          elect Screen elect Item : Select Change Opt. eneral Help F2: Previous Values F3: Optimized Defaults F4: Save & Reset ESC: Exit
---	--	--

Reset To Setup Mode

Deleting all variables will reset the  
System to Setup Mode  
Do you want to proceed?

---

Yes
No

Version 2.20.1275. Copyright (C) 2020 American Megatrends, Inc.

BIOS-Entry	Options
System Mode	None
Secure Boot	Disabled / Enabled Not Active
Secure Boot Mode	Custom / Standard
Reset To Setup Mode	Reset To Setup Mode (see box)

### 9.5.1.3 Key Management

Aptio Setup Utility - Copyright (C) 2020 American Megatrends, Inc.  
**Security**

<p>Vendor Keys <span style="float: right;">Valid</span></p> <p>Factory Key Provision <span style="float: right;">[Enabled]</span></p> <p>&gt; Restore Factory Keys</p> <p>&gt; Reset To Setup Mode</p> <p>&gt; Export Secure Boot variables</p> <p>&gt; Enroll Efi Image</p> <p>Device Guard Ready</p> <p>&gt; Remove 'UEFI CA' from DB</p> <p>&gt; Restore DB defaults</p> <table style="width: 100%; border-collapse: collapse; margin-top: 10px;"> <thead> <tr> <th style="text-align: left;">Secure Boot variable</th> <th style="text-align: left;">Size</th> <th style="text-align: left;">Keys</th> <th style="text-align: left;">Key Source</th> </tr> </thead> <tbody> <tr> <td>&gt; Platform Key (PK)</td> <td>862</td> <td>1</td> <td>Test (AMI)</td> </tr> <tr> <td>&gt; Key Exchange Keys</td> <td>1560</td> <td>1</td> <td>Factory</td> </tr> <tr> <td>&gt; Authorized Signatures</td> <td>3143</td> <td>2</td> <td>Factory</td> </tr> <tr> <td>&gt; Forbidden Signatures</td> <td>3724</td> <td>77</td> <td>Factory</td> </tr> <tr> <td>&gt; Authorized TimeStamps</td> <td>0</td> <td>0</td> <td>No Keys</td> </tr> <tr> <td>&gt; OsRecovery Signatures</td> <td>0</td> <td>0</td> <td>No Keys</td> </tr> </tbody> </table>	Secure Boot variable	Size	Keys	Key Source	> Platform Key (PK)	862	1	Test (AMI)	> Key Exchange Keys	1560	1	Factory	> Authorized Signatures	3143	2	Factory	> Forbidden Signatures	3724	77	Factory	> Authorized TimeStamps	0	0	No Keys	> OsRecovery Signatures	0	0	No Keys	<p>Install factory default Secure Boot keys after the platform reset and while the System is in Setup mode</p> <hr/> <p>←: Select Screen ↑↓: Select Item Enter: Select +/-: Change Opt. F1: General Help F2: Previous Values F3: Optimized Defaults F4: Save &amp; Reset ESC: Exit</p>
Secure Boot variable	Size	Keys	Key Source																										
> Platform Key (PK)	862	1	Test (AMI)																										
> Key Exchange Keys	1560	1	Factory																										
> Authorized Signatures	3143	2	Factory																										
> Forbidden Signatures	3724	77	Factory																										
> Authorized TimeStamps	0	0	No Keys																										
> OsRecovery Signatures	0	0	No Keys																										

Version 2.20.1275. Copyright (C) 2020 American Megatrends, Inc.

BIOS-Entry	Options
Vendor Keys	None
Factory Key Provision	Disabled / Enabled
Restore Factory Keys	Submenu see: <a href="#">Restore Factory Keys [▶ 79]</a>
Reset To Setup Mode	Submenu see: <a href="#">Reset To Setup Mode [▶ 80]</a>
Export Secure Boot variables	Submenu see: <a href="#">Export Secure Boot variables [▶ 81]</a>
Enroll Efi Image	Submenu see: <a href="#">Enroll Efi Image [▶ 81]</a>
Device Guard Ready	
Remove 'UEFI CA' from DB	Submenu see: <a href="#">Remove 'UEFI CA' from DB [▶ 82]</a>
Restore DB defaults	Submenu see: <a href="#">Restore DB defaults [▶ 83]</a>
Secure Boot variables	
PlatformKey(PK)	Press enter key
Key Exchange Keys	Press enter key
Authorized Signatures	Press enter key
Forbidden Signatures	Press enter key
Authorized TimeStamps	Press enter key
OsRecovery Signatures	Press enter key

**9.5.1.3.1 Restore Factory Keys**

Aptio Setup Utility - Copyright (C) 2020 American Megatrends, Inc.  
**Security**

<p>Vendor Keys Valid</p> <p>Factory Key Provision [Disabled]</p> <p>&gt; Restore Factory Keys</p> <p>&gt; Reset To Setup Mode</p> <p>&gt; Export Secure Boot variables</p> <p>&gt; Enroll Efi Image</p> <p>Device Guard Ready</p> <p>&gt; Remove 'UEFI CA' from DB</p> <p>&gt; Restore DB defaults</p> <table style="width: 100%; border-collapse: collapse;"> <tr> <td style="width: 30%;">Secure Boot variable</td> <td style="width: 10%;">Siz</td> <td style="width: 10%;"></td> <td style="width: 10%;"></td> <td style="width: 10%;"></td> <td style="width: 10%;"></td> <td style="width: 10%;"></td> <td style="width: 10%;"></td> </tr> <tr> <td>&gt; Platform Key (PK)</td> <td>86</td> <td></td> <td></td> <td></td> <td></td> <td></td> <td></td> </tr> <tr> <td>&gt; Key Exchange Keys</td> <td>156</td> <td></td> <td></td> <td></td> <td></td> <td></td> <td></td> </tr> <tr> <td>&gt; Authorized Signatures</td> <td>314</td> <td></td> <td></td> <td></td> <td></td> <td></td> <td></td> </tr> <tr> <td>&gt; Forbidden Signatures</td> <td>3724</td> <td></td> <td></td> <td></td> <td></td> <td></td> <td></td> </tr> <tr> <td>&gt; Authorized TimeStamps</td> <td>0</td> <td>0</td> <td>No Keys</td> <td></td> <td></td> <td></td> <td></td> </tr> <tr> <td>&gt; OsRecovery Signatures</td> <td>0</td> <td>0</td> <td>No Keys</td> <td></td> <td></td> <td></td> <td></td> </tr> </table>	Secure Boot variable	Siz							> Platform Key (PK)	86							> Key Exchange Keys	156							> Authorized Signatures	314							> Forbidden Signatures	3724							> Authorized TimeStamps	0	0	No Keys					> OsRecovery Signatures	0	0	No Keys					<p>Force System to User Mode. Install factory default Secure Boot key databases</p> <div style="border: 1px solid black; padding: 5px; margin: 10px auto; width: 80%;"> <p style="text-align: center;">Install factory defaults</p> <p style="text-align: center;">Press 'Yes' to proceed 'No' to cancel</p> <p style="text-align: center;">Yes No</p> </div> <p>elect Screen elect Item : Select Change Opt. F1: General Help F2: Previous Values F3: Optimized Defaults F4: Save &amp; Reset ESC: Exit</p>
Secure Boot variable	Siz																																																								
> Platform Key (PK)	86																																																								
> Key Exchange Keys	156																																																								
> Authorized Signatures	314																																																								
> Forbidden Signatures	3724																																																								
> Authorized TimeStamps	0	0	No Keys																																																						
> OsRecovery Signatures	0	0	No Keys																																																						

Version 2.20.1275. Copyright (C) 2020 American Megatrends, Inc.

BIOS-Entry	Options
Vendor Keys	None
Restore Factory Keys	Restore Factory Keys, see box

### 9.5.1.3.2 Reset To Setup Mode

Aptio Setup Utility - Copyright (C) 2020 American Megatrends, Inc.  
**Security**

<p>Vendor Keys Valid</p> <p>Factory Key Provision [Disabled]</p> <p>&gt; Restore Factory Keys</p> <p>&gt; Reset To Setup Mode</p> <p>&gt; Export Secure Boot variables</p> <p>&gt; Enroll Efi Image</p> <p>Device Guard Ready</p> <p>&gt; Remove 'UEFI CA' from DB</p> <p>&gt; Restore DB defaults</p> <p>Secure Boot variable   Siz</p> <p>&gt; Platform Key (PK)   86</p> <p>&gt; Key Exchange Keys   156</p> <p>&gt; Authorized Signatures   314</p> <p>&gt; Forbidden Signatures   372</p> <p>&gt; Authorized TimeStamps   0</p> <p>&gt; OsRecovery Signatures   0   0   No Keys</p>	<p>Delete all Secure Boot key databases from NVRAM</p> <hr/> <p>Reset To Setup Mode</p> <p>Deleting all variables will reset the System to Setup Mode</p> <p>Do you want to proceed?</p> <p style="text-align: center;">Yes                      No</p> <hr/> <p>elect Screen</p> <p>elect Item</p> <p>: Select</p> <p>Change Opt.</p> <p>eneral Help</p> <p>F2: Previous Values</p> <p>F3: Optimized Defaults</p> <p>F4: Save &amp; Reset</p> <p>ESC: Exit</p>
--	---

Version 2.20.1275. Copyright (C) 2020 American Megatrends, Inc.

BIOS-Entry	Options
Vendor Keys	None
Reset To Setup Mode	Reset To Setup Mode, see box



### 9.5.1.3.3 Export Secure Boot variables

Aptio Setup Utility - Copyright (C) 2020 American Megatrends, Inc.  
**Security**

<p>Vendor Keys <span style="float: right;">Valid</span></p> <p>Factory Key Provision <span style="float: right;">[Disabled]</span></p> <p>&gt; Restore Factory Keys</p> <p>&gt; Reset To Setup Mode</p> <p>&gt; Export Secure Boot variables</p> <p>&gt; Enroll Efi Image</p> <p>Device Guard Ready</p> <p>&gt; Remove 'UEFI CA' from DB</p> <p>&gt; Restore DB defaults</p> <table style="width: 100%; border-collapse: collapse;"> <tr> <td style="border-right: 1px solid black;">Secure Boot variable</td> <td style="border-right: 1px solid black;">Size</td> <td style="border-right: 1px solid black;">K</td> <td></td> </tr> <tr> <td style="border-right: 1px solid black;">&gt; Platform Key(PK)</td> <td style="border-right: 1px solid black;">862</td> <td style="border-right: 1px solid black;"></td> <td></td> </tr> <tr> <td style="border-right: 1px solid black;">&gt; Key Exchange Keys</td> <td style="border-right: 1px solid black;">1560</td> <td style="border-right: 1px solid black;"></td> <td></td> </tr> <tr> <td style="border-right: 1px solid black;">&gt; Authorized Signatures</td> <td style="border-right: 1px solid black;">3143</td> <td style="border-right: 1px solid black;"></td> <td></td> </tr> <tr> <td style="border-right: 1px solid black;">&gt; Forbidden Signatures</td> <td style="border-right: 1px solid black;">3724</td> <td style="border-right: 1px solid black;">7</td> <td></td> </tr> <tr> <td style="border-right: 1px solid black;">&gt; Authorized TimeStamps</td> <td style="border-right: 1px solid black;">0</td> <td style="border-right: 1px solid black;">0</td> <td>No Keys</td> </tr> <tr> <td style="border-right: 1px solid black;">&gt; OsRecovery Signatures</td> <td style="border-right: 1px solid black;">0</td> <td style="border-right: 1px solid black;">0</td> <td>No Keys</td> </tr> </table>	Secure Boot variable	Size	K		> Platform Key(PK)	862			> Key Exchange Keys	1560			> Authorized Signatures	3143			> Forbidden Signatures	3724	7		> Authorized TimeStamps	0	0	No Keys	> OsRecovery Signatures	0	0	No Keys	<p>Copy NVRAM content of Secure Boot variables to files in a root folder on a file system device</p> <div style="border: 1px solid black; padding: 5px; margin: 10px auto; width: fit-content;"> <p style="text-align: center;">File System</p> <p style="text-align: center;">No Valid File System Available</p> <p style="text-align: center;">Ok</p> </div> <p>: Select Screen : Select Item ter: Select -: Change Opt. F1: General Help F2: Previous Values F3: Optimized Defaults F4: Save &amp; Reset ESC: Exit</p>
Secure Boot variable	Size	K																											
> Platform Key(PK)	862																												
> Key Exchange Keys	1560																												
> Authorized Signatures	3143																												
> Forbidden Signatures	3724	7																											
> Authorized TimeStamps	0	0	No Keys																										
> OsRecovery Signatures	0	0	No Keys																										

Version 2.20.1275. Copyright (C) 2020 American Megatrends, Inc.

BIOS-Entry	Options
Vendor Keys	None
Export Secure Boot variables	File System, see box

### 9.5.1.3.4 Enroll Efi Image

Aptio Setup Utility - Copyright (C) 2020 American Megatrends, Inc.  
**Security**

<p>Vendor Keys <span style="float: right;">Valid</span></p> <p>Factory Key Provision <span style="float: right;">[Disabled]</span></p> <p>&gt; Restore Factory Keys</p> <p>&gt; Reset To Setup Mode</p> <p>&gt; Export Secure Boot variables</p> <p>&gt; Enroll Efi Image</p> <p>Device Guard Ready</p> <p>&gt; Remove 'UEFI CA' from DB</p> <p>&gt; Restore DB defaults</p> <table style="width: 100%; border-collapse: collapse;"> <tr> <td style="border-right: 1px solid black;">Secure Boot variable</td> <td style="border-right: 1px solid black;">Size</td> <td style="border-right: 1px solid black;">K</td> <td></td> </tr> <tr> <td style="border-right: 1px solid black;">&gt; Platform Key(PK)</td> <td style="border-right: 1px solid black;">862</td> <td style="border-right: 1px solid black;"></td> <td></td> </tr> <tr> <td style="border-right: 1px solid black;">&gt; Key Exchange Keys</td> <td style="border-right: 1px solid black;">1560</td> <td style="border-right: 1px solid black;"></td> <td></td> </tr> <tr> <td style="border-right: 1px solid black;">&gt; Authorized Signatures</td> <td style="border-right: 1px solid black;">3143</td> <td style="border-right: 1px solid black;"></td> <td></td> </tr> <tr> <td style="border-right: 1px solid black;">&gt; Forbidden Signatures</td> <td style="border-right: 1px solid black;">3724</td> <td style="border-right: 1px solid black;">7</td> <td></td> </tr> <tr> <td style="border-right: 1px solid black;">&gt; Authorized TimeStamps</td> <td style="border-right: 1px solid black;">0</td> <td style="border-right: 1px solid black;">0</td> <td>No Keys</td> </tr> <tr> <td style="border-right: 1px solid black;">&gt; OsRecovery Signatures</td> <td style="border-right: 1px solid black;">0</td> <td style="border-right: 1px solid black;">0</td> <td>No Keys</td> </tr> </table>	Secure Boot variable	Size	K		> Platform Key(PK)	862			> Key Exchange Keys	1560			> Authorized Signatures	3143			> Forbidden Signatures	3724	7		> Authorized TimeStamps	0	0	No Keys	> OsRecovery Signatures	0	0	No Keys	<p>Copy NVRAM content of Secure Boot variables to files in a root folder on a file system device</p> <div style="border: 1px solid black; padding: 5px; margin: 10px auto; width: fit-content;"> <p style="text-align: center;">File System</p> <p style="text-align: center;">No Valid File System Available</p> <p style="text-align: center;">Ok</p> </div> <p>: Select Screen : Select Item ter: Select -: Change Opt. F1: General Help F2: Previous Values F3: Optimized Defaults F4: Save &amp; Reset ESC: Exit</p>
Secure Boot variable	Size	K																											
> Platform Key(PK)	862																												
> Key Exchange Keys	1560																												
> Authorized Signatures	3143																												
> Forbidden Signatures	3724	7																											
> Authorized TimeStamps	0	0	No Keys																										
> OsRecovery Signatures	0	0	No Keys																										

Version 2.20.1275. Copyright (C) 2020 American Megatrends, Inc.

BIOS-Entry	Options
Vendor Keys	None
Enroll Efi Image	File System, see box

### 9.5.1.3.5 Remove UEFI CA from DB

Aptio Setup Utility - Copyright (C) 2020 American Megatrends, Inc.  
**Security**

<p>Vendor Keys Valid</p> <p>Factory Key Provision [Disabled]</p> <p>&gt; Restore Factory Keys</p> <p>&gt; Reset To Setup Mode</p> <p>&gt; Export Secure Boot variables</p> <p>&gt; Enroll Efi Image</p> <p>Device Guard Ready</p> <p>&gt; Remove 'UEFI CA' from DB</p> <p>&gt; Restore DB defaults</p> <table style="width: 100%; border-collapse: collapse;"> <tr> <td style="width: 30%;">Secure Boot variable</td> <td style="width: 10%;">Siz</td> <td style="width: 10%;"></td> <td style="width: 10%;"></td> <td style="width: 10%;"></td> <td style="width: 10%;"></td> </tr> <tr> <td>&gt; Platform Key (PK)</td> <td>86</td> <td></td> <td></td> <td></td> <td></td> </tr> <tr> <td>&gt; Key Exchange Keys</td> <td>156</td> <td></td> <td></td> <td></td> <td></td> </tr> <tr> <td>&gt; Authorized Signatures</td> <td>314</td> <td></td> <td></td> <td></td> <td></td> </tr> <tr> <td>&gt; Forbidden Signatures</td> <td>3724</td> <td></td> <td></td> <td></td> <td></td> </tr> <tr> <td>&gt; Authorized TimeStamps</td> <td>0</td> <td>0</td> <td>No Keys</td> <td></td> <td></td> </tr> <tr> <td>&gt; OsRecovery Signatures</td> <td>0</td> <td>0</td> <td>No Keys</td> <td></td> <td></td> </tr> </table>	Secure Boot variable	Siz					> Platform Key (PK)	86					> Key Exchange Keys	156					> Authorized Signatures	314					> Forbidden Signatures	3724					> Authorized TimeStamps	0	0	No Keys			> OsRecovery Signatures	0	0	No Keys			<p>Device Guard ready system must not list 'Microsoft UEFI CA' Certificate in Authorized Signature database (db)</p>
Secure Boot variable	Siz																																										
> Platform Key (PK)	86																																										
> Key Exchange Keys	156																																										
> Authorized Signatures	314																																										
> Forbidden Signatures	3724																																										
> Authorized TimeStamps	0	0	No Keys																																								
> OsRecovery Signatures	0	0	No Keys																																								

Remove 'UEFI CA' from DB

Press 'Yes' to proceed 'No' to cancel

Yes	No
-----	----

	<p>elect Screen</p> <p>elect Item</p> <p>: Select</p> <p>Change Opt.</p> <p>F1: General Help</p> <p>F2: Previous Values</p> <p>F3: Optimized Defaults</p> <p>F4: Save &amp; Reset</p> <p>ESC: Exit</p>
--	--

Version 2.20.1275. Copyright (C) 2020 American Megatrends, Inc.

BIOS-Entry	Options
Vendor Keys	None
Remove 'UEFI CA' from DB	Remove 'UEFI CA' from DB, see box

### 9.5.1.3.6 Restore DB Faults

```

Aptio Setup Utility - Copyright (C) 2020 American Megatrends, Inc.
  Security
-----
Vendor Keys                               Valid
Factory Key Provision                     [Disabled]
> Restore Factory Keys
> Reset To Setup Mode
> Export Secure Boot variables
> Enroll Efi Image

Device Guard Ready
> Remove 'UEFI CA' from DB
> Restore DB defaults

Secure Boot variable | Siz
> Platform Key (PK)  |  86
> Key Exchange Keys | 156
> Authorized Signatures | 314
> Forbidden Signatures | 3724
> Authorized TimeStamps | 0      0 | No Keys
> OsRecovery Signatures | 0      0 | No Keys

Restore DB defaults
Press 'Yes' to proceed 'No' to cancel

Yes                                     No

elect Screen
elect Item
: Select
Change Opt.
F1: General Help
F2: Previous Values
F3: Optimize Defaults
F4: Save & Reset
ESC: Exit

Version 2.20.1275. Copyright (C) 2020 American Megatrends, Inc.
    
```

BIOS-Entry	Options
Vendor Keys	None
Restore DB Faults	Restore DB Faults, see box

### 9.5.1.3.7 Platform Key (PK)

Aptio Setup Utility - Copyright (C) 2020 American Megatrends, Inc.  
**Security**

<p>Vendor Keys <span style="float: right;">Valid</span></p> <p>Factory Key Provision <span style="float: right;">[Disabled]</span></p> <p>&gt; Restore Factory Keys</p> <p>&gt; Reset To Setup Mode</p> <p>&gt; Export Secure Boot variables</p> <p>&gt; Enroll Efi Image</p> <p>Device Guard Ready</p> <p>&gt; Remove 'UEFI CA' from DB</p> <p>&gt; Restore DB defaults</p> <table border="1" style="width: 100%; border-collapse: collapse; margin-top: 10px;"> <tr> <th colspan="4" style="text-align: center;">Platform Key (PK)</th> </tr> <tr> <td style="width: 30%;"></td> <td style="width: 10%;"></td> <td style="width: 10%;"></td> <td style="width: 50%;">Details</td> </tr> <tr> <td></td> <td></td> <td></td> <td>Export</td> </tr> <tr> <td></td> <td></td> <td></td> <td>Update</td> </tr> <tr> <td></td> <td></td> <td></td> <td>Delete</td> </tr> </table> <table border="1" style="width: 100%; border-collapse: collapse; margin-top: 10px;"> <thead> <tr> <th style="width: 60%;">Secure Boot variable</th> <th style="width: 10%;">Size</th> <th style="width: 10%;">Ke</th> <th style="width: 20%;"></th> </tr> </thead> <tbody> <tr> <td>&gt; Platform Key (PK)</td> <td style="text-align: center;">862</td> <td></td> <td></td> </tr> <tr> <td>&gt; Key Exchange Keys</td> <td style="text-align: center;">1560</td> <td></td> <td></td> </tr> <tr> <td>&gt; Authorized Signatures</td> <td style="text-align: center;">3143</td> <td style="text-align: center;">2</td> <td>Factory</td> </tr> <tr> <td>&gt; Forbidden Signatures</td> <td style="text-align: center;">3724</td> <td style="text-align: center;">77</td> <td>Factory</td> </tr> <tr> <td>&gt; Authorized TimeStamps</td> <td style="text-align: center;">0</td> <td style="text-align: center;">0</td> <td>No Keys</td> </tr> <tr> <td>&gt; OsRecovery Signatures</td> <td style="text-align: center;">0</td> <td style="text-align: center;">0</td> <td>No Keys</td> </tr> </tbody> </table>	Platform Key (PK)							Details				Export				Update				Delete	Secure Boot variable	Size	Ke		> Platform Key (PK)	862			> Key Exchange Keys	1560			> Authorized Signatures	3143	2	Factory	> Forbidden Signatures	3724	77	Factory	> Authorized TimeStamps	0	0	No Keys	> OsRecovery Signatures	0	0	No Keys	<p>Enroll Factory Defaults or load certificates from a file:</p> <p>1.Public Key Certificate:</p> <p>a)EFI_SIGNATURE_LIST</p> <p>b)EFI_CERT_X509 (DER)</p> <p>c)EFI_CERT_RSA2048 (bin)</p> <p>d)EFI_CERT_SHAXXX</p> <p>2.Authenticated UEFI Variable</p> <p>3.EFI PE/COFF Image (SHA256)</p> <p>Key Source:</p> <p>Factory,External,Mixed</p> <hr/> <p>←: Select Screen</p> <p>↑↓: Select Item</p> <p>Enter: Select</p> <p>+/-: Change Opt.</p> <p>F1: General Help</p> <p>F2: Previous Values</p> <p>F3: Optimized Defaults</p> <p>F4: Save &amp; Reset</p> <p>ESC: Exit</p>
Platform Key (PK)																																																	
			Details																																														
			Export																																														
			Update																																														
			Delete																																														
Secure Boot variable	Size	Ke																																															
> Platform Key (PK)	862																																																
> Key Exchange Keys	1560																																																
> Authorized Signatures	3143	2	Factory																																														
> Forbidden Signatures	3724	77	Factory																																														
> Authorized TimeStamps	0	0	No Keys																																														
> OsRecovery Signatures	0	0	No Keys																																														

Version 2.20.1275. Copyright (C) 2020 American Megatrends, Inc.

BIOS-Entry	Options
Vendor Keys	None
Platform Key (PK)	Platform Key (PK), see box

**9.5.1.3.8 Platform Key (PK)**

Aptio Setup Utility - Copyright (C) 2020 American Megatrends, Inc.  
**Security**

<p>Vendor Keys <span style="float: right;">Valid</span></p> <p>Factory Key Provision <span style="float: right;">[Disabled]</span></p> <p>&gt; Restore Factory Keys</p> <p>&gt; Reset To Setup Mode</p> <p>&gt; Export Secure Boot variables</p> <p>&gt; Enroll Efi Image</p> <p>Device Guard Ready</p> <p>&gt; Remove 'UEFI CA' from DB</p> <p>&gt; Restore DB defaults</p> <table border="1" style="width: 100%; border-collapse: collapse; margin-top: 10px;"> <tr> <th colspan="4" style="text-align: center;">Platform Key (PK)</th> </tr> <tr> <td style="width: 30%;"></td> <td style="width: 10%;"></td> <td style="width: 10%;"></td> <td style="width: 50%;">Details</td> </tr> <tr> <td></td> <td></td> <td></td> <td>Export</td> </tr> <tr> <td></td> <td></td> <td></td> <td>Update</td> </tr> <tr> <td></td> <td></td> <td></td> <td>Delete</td> </tr> </table> <table border="1" style="width: 100%; border-collapse: collapse; margin-top: 10px;"> <thead> <tr> <th style="width: 30%;">Secure Boot variable</th> <th style="width: 10%;">Size</th> <th style="width: 10%;">Ke</th> <th style="width: 50%;"></th> </tr> </thead> <tbody> <tr> <td>&gt; Platform Key (PK)</td> <td style="text-align: center;">862</td> <td></td> <td></td> </tr> <tr> <td>&gt; Key Exchange Keys</td> <td style="text-align: center;">1560</td> <td></td> <td></td> </tr> <tr> <td>&gt; Authorized Signatures</td> <td style="text-align: center;">3143</td> <td style="text-align: center;">2</td> <td>Factory</td> </tr> <tr> <td>&gt; Forbidden Signatures</td> <td style="text-align: center;">3724</td> <td style="text-align: center;">77</td> <td>Factory</td> </tr> <tr> <td>&gt; Authorized TimeStamps</td> <td style="text-align: center;">0</td> <td style="text-align: center;">0</td> <td>No Keys</td> </tr> <tr> <td>&gt; OsRecovery Signatures</td> <td style="text-align: center;">0</td> <td style="text-align: center;">0</td> <td>No Keys</td> </tr> </tbody> </table>	Platform Key (PK)							Details				Export				Update				Delete	Secure Boot variable	Size	Ke		> Platform Key (PK)	862			> Key Exchange Keys	1560			> Authorized Signatures	3143	2	Factory	> Forbidden Signatures	3724	77	Factory	> Authorized TimeStamps	0	0	No Keys	> OsRecovery Signatures	0	0	No Keys	<p>Enroll Factory Defaults or load certificates from a file:</p> <p>1.Public Key Certificate:</p> <p>a)EFI_SIGNATURE_LIST</p> <p>b)EFI_CERT_X509 (DER)</p> <p>c)EFI_CERT_RSA2048 (bin)</p> <p>d)EFI_CERT_SHAXXX</p> <p>2.Authenticated UEFI Variable</p> <p>3.EFI PE/COFF Image (SHA256)</p> <p>Key Source:</p> <p>Factory,External,Mixed</p> <hr/> <p>←: Select Screen</p> <p>↑↓: Select Item</p> <p>Enter: Select</p> <p>+/-: Change Opt.</p> <p>F1: General Help</p> <p>F2: Previous Values</p> <p>F3: Optimized Defaults</p> <p>F4: Save &amp; Reset</p> <p>ESC: Exit</p>
Platform Key (PK)																																																	
			Details																																														
			Export																																														
			Update																																														
			Delete																																														
Secure Boot variable	Size	Ke																																															
> Platform Key (PK)	862																																																
> Key Exchange Keys	1560																																																
> Authorized Signatures	3143	2	Factory																																														
> Forbidden Signatures	3724	77	Factory																																														
> Authorized TimeStamps	0	0	No Keys																																														
> OsRecovery Signatures	0	0	No Keys																																														

Version 2.20.1275. Copyright (C) 2020 American Megatrends, Inc.

BIOS-Entry	Options
Vendor Keys	None
Platform Key (PK)	Platform Key (PK), see box

### 9.5.1.3.9 Authorized Signatures

Aptio Setup Utility - Copyright (C) 2020 American Megatrends, Inc.  
**Security**

<p>Vendor Keys <span style="float: right;">Valid</span></p> <p>Factory Key Provision <span style="float: right;">[Disabled]</span></p> <p>&gt; Restore Factory Keys</p> <p>&gt; Reset To Setup Mode</p> <p>&gt; Export Secure Boot variables</p> <p>&gt; Enroll Efi Image</p> <p>Device Guard Ready</p> <p>&gt; Remove 'UEFI CA' from DB</p> <p>&gt; Restore DB defaults</p> <table style="width: 100%; border-collapse: collapse;"> <tr> <td style="width: 25%;">Secure Boot variable</td> <td style="width: 10%;">Size</td> <td style="width: 10%;">Ke</td> <td style="width: 55%;"></td> </tr> <tr> <td>&gt; Platform Key (PK)</td> <td style="text-align: center;">862</td> <td></td> <td></td> </tr> <tr> <td>&gt; Key Exchange Keys</td> <td style="text-align: center;">1560</td> <td></td> <td></td> </tr> <tr> <td>&gt; Authorized Signatures</td> <td style="text-align: center;">3143</td> <td></td> <td></td> </tr> <tr> <td>&gt; Forbidden Signatures</td> <td style="text-align: center;">3724</td> <td style="text-align: center;">77</td> <td>Factory</td> </tr> <tr> <td>&gt; Authorized TimeStamps</td> <td style="text-align: center;">0</td> <td style="text-align: center;">0</td> <td>No Keys</td> </tr> <tr> <td>&gt; OsRecovery Signatures</td> <td style="text-align: center;">0</td> <td style="text-align: center;">0</td> <td>No Keys</td> </tr> </table>	Secure Boot variable	Size	Ke		> Platform Key (PK)	862			> Key Exchange Keys	1560			> Authorized Signatures	3143			> Forbidden Signatures	3724	77	Factory	> Authorized TimeStamps	0	0	No Keys	> OsRecovery Signatures	0	0	No Keys	<div style="border: 1px solid black; padding: 5px; margin-bottom: 10px;"> <p style="text-align: center;">Authorized Signatures</p> <hr/> <p>Details</p> <p>Export</p> <p>Update</p> <p>Append</p> <p>Delete</p> </div> <p>Enroll Factory Defaults or load certificates from a file:</p> <p>1.Public Key Certificate:</p> <p>a)EFI_SIGNATURE_LIST</p> <p>b)EFI_CERT_X509 (DER)</p> <p>c)EFI_CERT_RSA2048 (bin)</p> <p>d)EFI_CERT_SHAXXX</p> <p>2.Authenticated UEFI Variable</p> <p>3.EFI PE/COFF Image (SHA256)</p> <p>Key Source:</p> <p>Factory, External, Mixed</p> <hr/> <p>←: Select Screen</p> <p>↑↓: Select Item</p> <p>Enter: Select</p> <p>+/-: Change Opt.</p> <p>F1: General Help</p> <p>F2: Previous Values</p> <p>F3: Optimized Defaults</p> <p>F4: Save &amp; Reset</p> <p>ESC: Exit</p>
Secure Boot variable	Size	Ke																											
> Platform Key (PK)	862																												
> Key Exchange Keys	1560																												
> Authorized Signatures	3143																												
> Forbidden Signatures	3724	77	Factory																										
> Authorized TimeStamps	0	0	No Keys																										
> OsRecovery Signatures	0	0	No Keys																										

Version 2.20.1275. Copyright (C) 2020 American Megatrends, Inc.

BIOS-Entry	Options
Vendor Keys	None
Authorized Signatures	Authorized Signatures, see box

**9.5.1.3.10 Forbidden Signatures**

Aptio Setup Utility - Copyright (C) 2020 American Megatrends, Inc.  
**Security**

<p>Vendor Keys <span style="float: right;">Valid</span></p> <p>Factory Key Provision <span style="float: right;">[Disabled]</span></p> <p>&gt; Restore Factory Keys</p> <p>&gt; Reset To Setup Mode</p> <p>&gt; Export Secure Boot variables</p> <p>&gt; Enroll Efi Image</p> <p>Device Guard Ready</p> <p>&gt; Remove 'UEFI CA' from DB</p> <p>&gt; Restore DB defaults</p> <table style="width: 100%; border-collapse: collapse;"> <tr> <td style="width: 30%;">Secure Boot variable</td> <td style="width: 10%;">Size</td> <td style="width: 10%;">Ke</td> <td style="width: 50%;"></td> </tr> <tr> <td>&gt; Platform Key (PK)</td> <td>862</td> <td></td> <td></td> </tr> <tr> <td>&gt; Key Exchange Keys</td> <td>1560</td> <td></td> <td></td> </tr> <tr> <td>&gt; Authorized Signatures</td> <td>3143</td> <td></td> <td></td> </tr> <tr> <td>&gt; Forbidden Signatures</td> <td>3724</td> <td>77</td> <td>Factory</td> </tr> <tr> <td>&gt; Authorized TimeStamps</td> <td>0</td> <td>0</td> <td>No Keys</td> </tr> <tr> <td>&gt; OsRecovery Signatures</td> <td>0</td> <td>0</td> <td>No Keys</td> </tr> </table>	Secure Boot variable	Size	Ke		> Platform Key (PK)	862			> Key Exchange Keys	1560			> Authorized Signatures	3143			> Forbidden Signatures	3724	77	Factory	> Authorized TimeStamps	0	0	No Keys	> OsRecovery Signatures	0	0	No Keys	<div style="border: 1px solid black; padding: 5px; margin-bottom: 10px; text-align: center;"> <b>Forbidden Signatures</b> </div> <div style="border: 1px solid black; padding: 5px; margin-bottom: 10px;">                 Details                  Export                  Update                  Append                  Delete             </div> <p>Enroll Factory Defaults or load certificates from a file:</p> <p>1.Public Key Certificate:</p> <p>a)EFI_SIGNATURE_LIST</p> <p>b)EFI_CERT_X509 (DER)</p> <p>c)EFI_CERT_RSA2048 (bin)</p> <p>d)EFI_CERT_SHAXXX</p> <p>2.Authenticated UEFI Variable</p> <p>3.EFI PE/COFF Image (SHA256)</p> <p>Key Source: Factory, External, Mixed</p> <hr/> <p>←: Select Screen                  ↑↓: Select Item                  Enter: Select                  +/-: Change Opt.                  F1: General Help                  F2: Previous Values                  F3: Optimized Defaults                  F4: Save &amp; Reset                  ESC: Exit</p>
Secure Boot variable	Size	Ke																											
> Platform Key (PK)	862																												
> Key Exchange Keys	1560																												
> Authorized Signatures	3143																												
> Forbidden Signatures	3724	77	Factory																										
> Authorized TimeStamps	0	0	No Keys																										
> OsRecovery Signatures	0	0	No Keys																										

Version 2.20.1275. Copyright (C) 2020 American Megatrends, Inc.

BIOS-Entry	Options
Vendor Keys	None
Forbidden Signatures	Forbidden Signatures, see box

### 9.5.1.3.11 Authorized TimeStamps

Aptio Setup Utility - Copyright (C) 2020 American Megatrends, Inc.  
**Security**

<p>Vendor Keys <span style="float: right;">Valid</span></p> <p>Factory Key Provision <span style="float: right;">[Disabled]</span></p> <p>&gt; Restore Factory Keys</p> <p>&gt; Reset To Setup Mode</p> <p>&gt; Export Secure Boot variables</p> <p>&gt; Enroll Efi Image</p> <p>Device Guard Ready</p> <p>&gt; Remove 'UEFI CA' from DB</p> <p>&gt; Restore DB defaults</p> <table style="width: 100%; border-collapse: collapse;"> <tr> <td style="width: 25%;">Secure Boot variable</td> <td style="width: 10%;">Size</td> <td style="width: 10%;">Ke</td> <td style="width: 55%;"></td> </tr> <tr> <td>&gt; Platform Key (PK)</td> <td>862</td> <td></td> <td></td> </tr> <tr> <td>&gt; Key Exchange Keys</td> <td>1560</td> <td>1</td> <td>Factory</td> </tr> <tr> <td>&gt; Authorized Signatures</td> <td>3143</td> <td>2</td> <td>Factory</td> </tr> <tr> <td>&gt; Forbidden Signatures</td> <td>3724</td> <td>77</td> <td>Factory</td> </tr> <tr> <td>&gt; Authorized TimeStamps</td> <td>0</td> <td>0</td> <td>No Keys</td> </tr> <tr> <td>&gt; OsRecovery Signatures</td> <td>0</td> <td>0</td> <td>No Keys</td> </tr> </table>	Secure Boot variable	Size	Ke		> Platform Key (PK)	862			> Key Exchange Keys	1560	1	Factory	> Authorized Signatures	3143	2	Factory	> Forbidden Signatures	3724	77	Factory	> Authorized TimeStamps	0	0	No Keys	> OsRecovery Signatures	0	0	No Keys	<p>Enroll Factory Defaults or load certificates from a file:</p> <p>1.Public Key Certificate:</p> <p>a)EFI_SIGNATURE_LIST</p> <p>b)EFI_CERT_X509 (DER)</p> <p>c)EFI_CERT_RSA2048 (bin)</p> <p>d)EFI_CERT_SHAXXX</p> <p>2.Authenticated UEFI Variable</p> <p>3.EFI PE/COFF Image (SHA256)</p> <p>Key Source: Factory, External, Mixed</p> <hr/> <p>←: Select Screen</p> <p>↑↓: Select Item</p> <p>Enter: Select</p> <p>+/-: Change Opt.</p> <p>F1: General Help</p> <p>F2: Previous Values</p> <p>F3: Optimized Defaults</p> <p>F4: Save &amp; Reset</p> <p>ESC: Exit</p>
Secure Boot variable	Size	Ke																											
> Platform Key (PK)	862																												
> Key Exchange Keys	1560	1	Factory																										
> Authorized Signatures	3143	2	Factory																										
> Forbidden Signatures	3724	77	Factory																										
> Authorized TimeStamps	0	0	No Keys																										
> OsRecovery Signatures	0	0	No Keys																										

Authorized TimeStamps

---

Update  
Append

Version 2.20.1275. Copyright (C) 2020 American Megatrends, Inc.

BIOS-Entry	Options
Vendor Keys	None
Authorized TimeStamps	Authorized TimeStamps, see box



**9.5.1.3.12 OsRecovery Signatures**

Aptio Setup Utility - Copyright (C) 2020 American Megatrends, Inc.  
**Security**

<p>Vendor Keys <span style="float: right;">Valid</span></p> <p>Factory Key Provision <span style="float: right;">[Disabled]</span></p> <p>&gt; Restore Factory Keys</p> <p>&gt; Reset To Setup Mode</p> <p>&gt; Export Secure Boot variables</p> <p>&gt; Enroll Efi Image</p> <p>Device Guard Ready</p> <p>&gt; Remove 'UEFI CA' from DB</p> <p>&gt; Restore DB defaults</p> <table border="1" style="margin-left: auto; margin-right: auto; border-collapse: collapse;"> <tr> <th colspan="4" style="text-align: center;">OsRecovery Signatures</th> </tr> <tr> <td style="width: 15%;"></td> <td style="width: 15%; text-align: center;">Update</td> <td style="width: 15%;"></td> <td style="width: 55%;"></td> </tr> <tr> <td></td> <td style="text-align: center;">Append</td> <td></td> <td></td> </tr> </table> <table border="1" style="margin-top: 10px; border-collapse: collapse;"> <thead> <tr> <th style="width: 25%;">Secure Boot variable</th> <th style="width: 10%;">Size</th> <th style="width: 10%;">Ke</th> <th style="width: 55%;"></th> </tr> </thead> <tbody> <tr> <td>&gt; Platform Key (PK)</td> <td style="text-align: center;">862</td> <td></td> <td></td> </tr> <tr> <td>&gt; Key Exchange Keys</td> <td style="text-align: center;">1560</td> <td style="text-align: center;">1</td> <td>Factory</td> </tr> <tr> <td>&gt; Authorized Signatures</td> <td style="text-align: center;">3143</td> <td style="text-align: center;">2</td> <td>Factory</td> </tr> <tr> <td>&gt; Forbidden Signatures</td> <td style="text-align: center;">3724</td> <td style="text-align: center;">77</td> <td>Factory</td> </tr> <tr> <td>&gt; Authorized TimeStamps</td> <td style="text-align: center;">0</td> <td style="text-align: center;">0</td> <td>No Keys</td> </tr> <tr> <td>&gt; OsRecovery Signatures</td> <td style="text-align: center;">0</td> <td style="text-align: center;">0</td> <td>No Keys</td> </tr> </tbody> </table>	OsRecovery Signatures					Update				Append			Secure Boot variable	Size	Ke		> Platform Key (PK)	862			> Key Exchange Keys	1560	1	Factory	> Authorized Signatures	3143	2	Factory	> Forbidden Signatures	3724	77	Factory	> Authorized TimeStamps	0	0	No Keys	> OsRecovery Signatures	0	0	No Keys	<p>Enroll Factory Defaults or load certificates from a file:</p> <p>1.Public Key Certificate:</p> <p>a)EFI_SIGNATURE_LIST</p> <p>b)EFI_CERT_X509 (DER)</p> <p>c)EFI_CERT_RSA2048 (bin)</p> <p>d)EFI_CERT_SHAXXX</p> <p>2.Authenticated UEFI Variable</p> <p>3.EFI PE/COFF Image (SHA256)</p> <p>Key Source:</p> <p>Factory,External,Mixed</p> <hr/> <p>←: Select Screen</p> <p>↑↓: Select Item</p> <p>Enter: Select</p> <p>+/-: Change Opt.</p> <p>F1: General Help</p> <p>F2: Previous Values</p> <p>F3: Optimized Defaults</p> <p>F4: Save &amp; Reset</p> <p>ESC: Exit</p>
OsRecovery Signatures																																									
	Update																																								
	Append																																								
Secure Boot variable	Size	Ke																																							
> Platform Key (PK)	862																																								
> Key Exchange Keys	1560	1	Factory																																						
> Authorized Signatures	3143	2	Factory																																						
> Forbidden Signatures	3724	77	Factory																																						
> Authorized TimeStamps	0	0	No Keys																																						
> OsRecovery Signatures	0	0	No Keys																																						

Version 2.20.1275. Copyright (C) 2020 American Megatrends, Inc.

BIOS-Entry	Options
Vendor Keys	None
OsRecovery Signatures	OsRecovery Signatures, see box

## 9.6 Boot

Aptio Setup Utility – Copyright (C) 2020 American Megatrends, Inc.  
Main Advanced Chipset Security **Boot** Save & Exit

<pre> Boot Configuration Setup Prompt Timeout          1 Bootup NumLock State         [Off]  F7 Boot Menu                  [Enabled]  Quiet Boot                    [Enabled] Fast Boot                     [Disable Link]  Boot mode select              [UEFI]  FIXED BOOT ORDER Priorities Boot Option #1                [UEFI Service Stick] Boot Option #2                [UEFI CFast] Boot Option #3                [UEFI SSD] Boot Option #4                [UEFI HDD] Boot Option #5                [UEFI CD/DVD] Boot Option #6                [UEFI USB Stick] Boot Option #7                [UEFI USB Floppy] Boot Option #8                [UEFI USB Hard Disk] Boot Option #9                [UEFI USB CD/DVD] Boot Option #10               [UEFI Network] Boot Option #11               [UEFI USB Lan]  &gt; Advanced Fixed Boot Order Parameters                 </pre>	<p>Number of seconds to wait for setup activation key. 65535(0xFFFF) means indefinite waiting.</p> <hr/> <pre> ←→: Select Screen ↑↓: Select Item Enter: Select +/-: Change Opt. F1: General Help F2: Previous Values F3: Optimized Defaults F4: Save &amp; Reset ESC: Exit                 </pre>
---	---

Version 2.20.1275. Copyright (C) 2020 American Megatrends, Inc.

BIOS-Entry	Options
<b>Boot Configuration</b>	
Setup Prompt Timeout	None
Bootup NumLok State	On / Off
F7 Boot Menu	Enabled / Disabled
Quiet Boot	Enabled / Disabled
Fast Boot	Disable Link / Enabled
<b>Driver Option Priorities</b>	
Boot mode select	None
<b>Fixed Boot Order Priorities</b>	
Boot Option #1 - 11	Set here the order of boot media to be used.
Advanced Fixed Boot Order Parameters	Submenu see: <a href="#">Advanced Fixed Boot Order Parameters</a> [▶ 91]

### 9.6.1 Advanced Fixed Boot Order Parameters

Aptio Setup Utility - Copyright (C) 2020 American Megatrends, Inc.  
**Boot**

<table style="width: 100%; border-collapse: collapse;"> <tr><td style="width: 35%;">Min. CFAST capacity (GB)</td><td style="width: 25%;">0</td><td style="width: 40%;"></td></tr> <tr><td>Max. CFAST capacity (GB)</td><td>119</td><td></td></tr> <tr><td>Min. SSD capacity (GB)</td><td>119</td><td></td></tr> <tr><td>Max. SSD capacity (GB)</td><td>481</td><td></td></tr> <tr><td>Min. HDD capacity (GB)</td><td>481</td><td></td></tr> <tr><td>Max. HDD capacity (GB)</td><td>8000000</td><td></td></tr> <tr><td>Max. USB Stick capacity (GB)</td><td>64</td><td></td></tr> <tr><td colspan="3"> </td></tr> <tr><td>UEFI BDS Boot Filter</td><td>[Enabled]</td><td></td></tr> <tr><td>Re-enable UEFI Disks</td><td>[Enabled]</td><td></td></tr> </table>	Min. CFAST capacity (GB)	0		Max. CFAST capacity (GB)	119		Min. SSD capacity (GB)	119		Max. SSD capacity (GB)	481		Min. HDD capacity (GB)	481		Max. HDD capacity (GB)	8000000		Max. USB Stick capacity (GB)	64					UEFI BDS Boot Filter	[Enabled]		Re-enable UEFI Disks	[Enabled]		Lower capacity limit for boot group CFAST in GB            ←: Select Screen ↑↓: Select Item Enter: Select +/-: Change Opt. F1: General Help F2: Previous Values F3: Optimized Defaults F4: Save & Reset ESC: Exit
Min. CFAST capacity (GB)	0																														
Max. CFAST capacity (GB)	119																														
Min. SSD capacity (GB)	119																														
Max. SSD capacity (GB)	481																														
Min. HDD capacity (GB)	481																														
Max. HDD capacity (GB)	8000000																														
Max. USB Stick capacity (GB)	64																														
UEFI BDS Boot Filter	[Enabled]																														
Re-enable UEFI Disks	[Enabled]																														

Version 2.20.1275. Copyright (C) 2020 American Megatrends, Inc.

BIOS-Entry	Options
Min. CFAST capacity (GB)	None
Max. CFAST capacity (GB)	None
Min. SSD capacity (GB)	None
Max. SSD capacity (GB)	None
Min. HDD capacity (GB)	None
Max. HDD capacity (GB)	None
Max. USB Stick capacity (GB)	None
UEFI BDS Boot Filter	Enabled / Disabled
Re-enable UEFI Disks	Enabled / Disabled

## 9.7 Save & Exit

Aptio Setup Utility - Copyright (C) 2020 American Megatrends, Inc.  
 Main Advanced Chipset Security Boot **Save & Exit**

Save Changes and Reset Discard Changes and Reset  Restore Defaults  Boot Override Launch EFI Shell from filesystem device	Reset the system after saving the changes.   ←: Select Screen ↑↓: Select Item Enter: Select +/-: Change Opt. F1: General Help F2: Previous Values F3: Optimized Defaults F4: Save & Reset ESC: Exit
---	--

Version 2.20.1275. Copyright (C) 2020 American Megatrends, Inc.

BIOS-Entry	Options
Save Changes and Reset	
Discard Changes and Reset	Press enter key
Restore Optimized Defaults	Press enter key
Boot Override	
Launch EFI Shell from filesystem device	Press enter key

# 10 Mechanical drawings

## 10.1 PCB: Holes

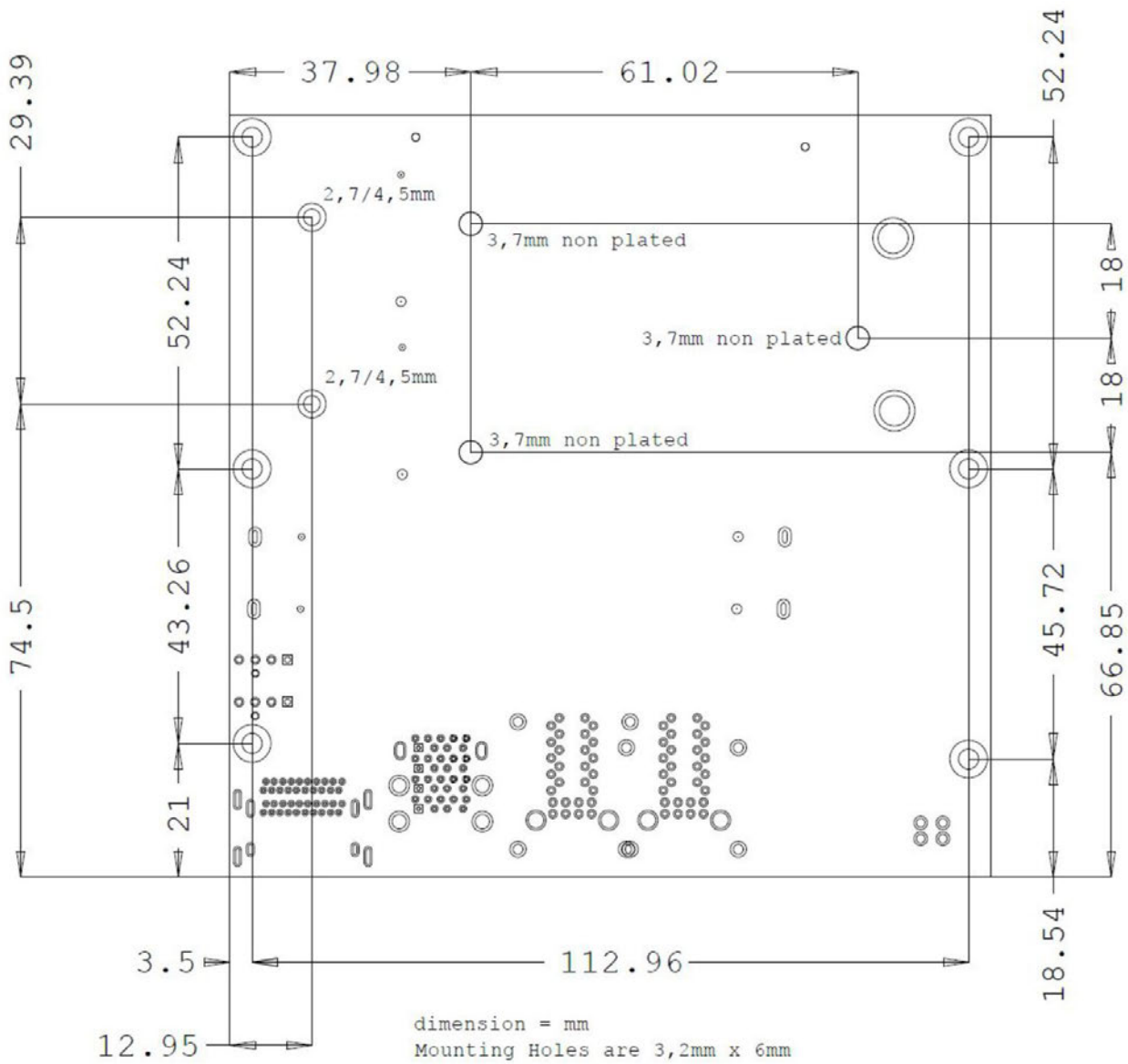

Fig. 16: MZ MH CB6467

### 10.2 PCB: Pin 1 distances

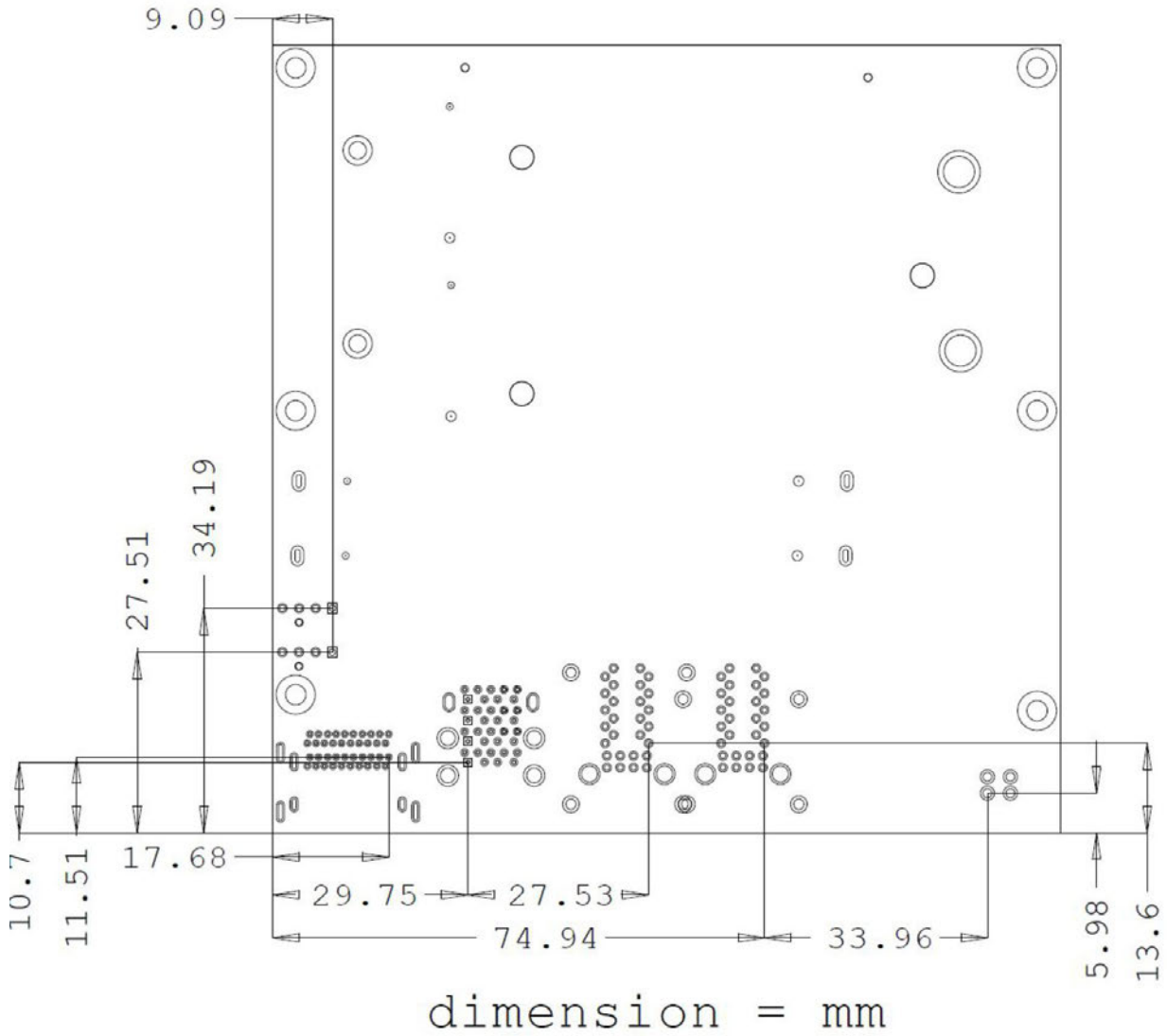
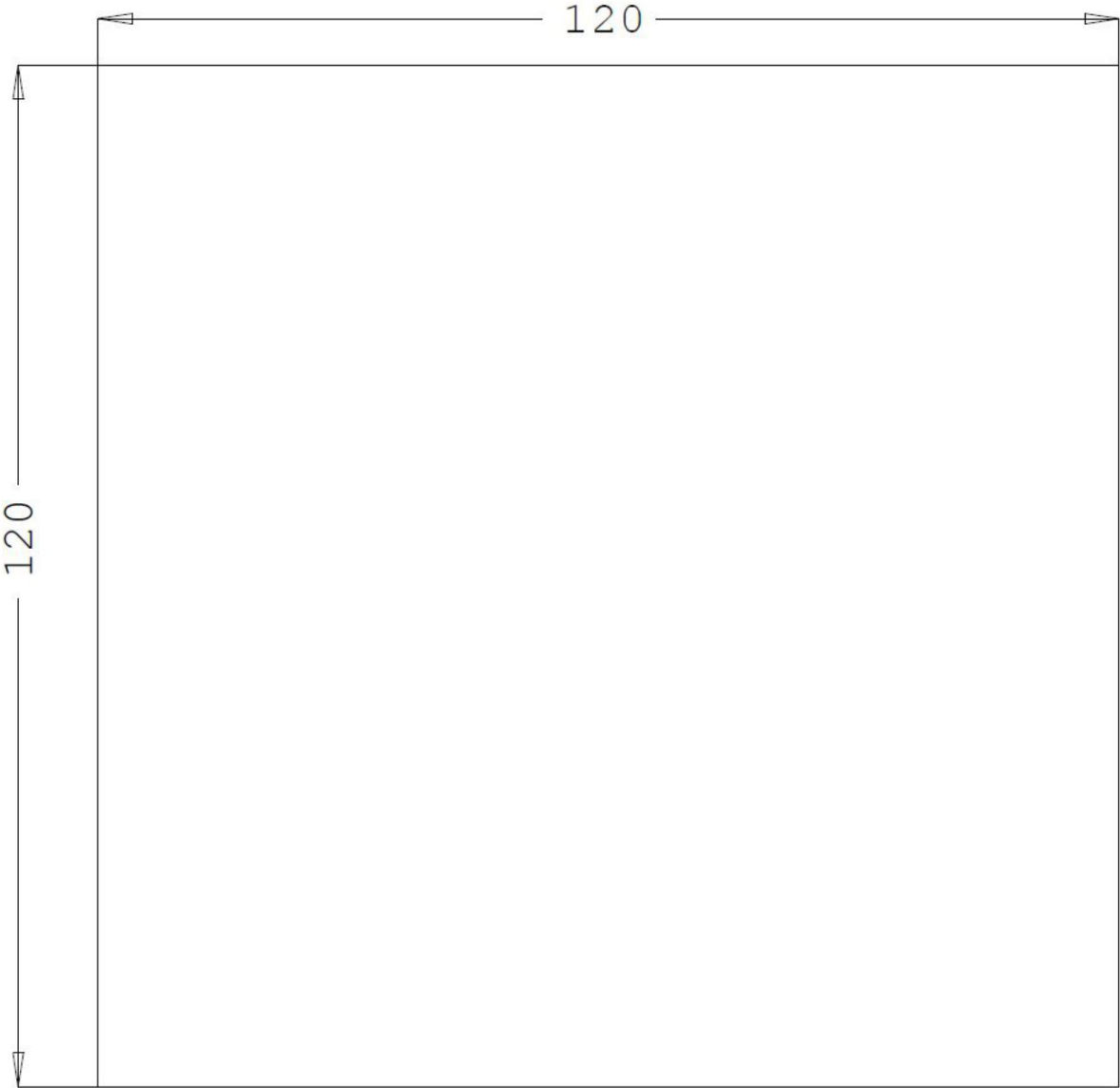

Fig. 17: MZ PIN1 CB6467

10.3 PCB: Dimensions



dimension = mm

Fig. 18: MZ CB6467

# 11 Technical data

## 11.1 Electrical data

Power supply	
Board	24 VDC power supply unit (+20 % / - 15 %)
RTC	≥3A

Power	
transformer	95 W continuous load 150 W peak load

Current consumption	
RTC	≤ 10 $\mu$ m

## 11.2 Environmental conditions

Temperature range	
Operating	0 °C to +60 °C (extended temperature range on request)
Storage	-25 °C to +85 °C
Dispatch	-25 °C to +85 °C, for packed boards

Temperature changes	
Operating	0.5 °C per minute, 7.5 °C in 30 minutes
Storage	1.0 °C per minute
Dispatch	1.0 °C per minute, for packed boards

Relative humidity	
Operating	5% to 85% (non-condensing)
Storage	5% to 95% (non-condensing)
Dispatch	5% to 100% (non-condensing), for packed boards

Impact	
Operating	150 m/s <sup>2</sup> , 6 ms
Storage	400 m/s <sup>2</sup> , 6 ms
Dispatch	400 m/s <sup>2</sup> , 6 ms, for packed boards

Vibration	
Operating	10 to 58 Hz, amplitude 0.075 mm
Storage	5 to 9 Hz, amplitude 3.5 mm 9 to 500 Hz, 10 m/s <sup>2</sup>
Dispatch	5 to 9 Hz, amplitude 3.5 mm 9 to 500 Hz, 10 m/s <sup>2</sup> , for packed boards

### **i** Note on impact and vibration resistance

The specifications for impact and vibration resistance refer only to the motherboard itself without heat sink, memory module, cabling, etc.



## 11.3 Technical specifications

The board is specified for an ambient temperature range of 0 °C to +60 °C (extended temperature range on request). In addition, care must be taken that the temperature of the processor die does not exceed 100 °C. To ensure this a suitable cooling concept must be implemented that is oriented to the maximum power consumption of the processor/chipset. It must also be ensured that any existing controllers are included in the cooling concept. The power consumption of these function blocks may be of the same order of magnitude as the power consumption of the processor. The board is prepared with suitable holes for the use of modern cooling solutions. We have a series of compatible cooling components in our range. Your distributor will be pleased to assist you in selecting suitable solutions.

### NOTE

#### **Prevent the maximum die temperature being exceeded!**

It is the end customer's responsibility to ensure that the die temperature of the processor does not exceed 100 °C! Continuous overheating can destroy the board!

If the temperature exceeds 100 °C, the ambient temperature needs to be reduced. Ensure sufficient air circulation if necessary.

## 12 Support and Service

### 12.1 Beckhoff Support

Beckhoff Support offers you comprehensive technical assistance, helping you not only with the application of individual Beckhoff products, but also with other, wide-ranging services:

- world-wide support
- design, programming and commissioning of complex automation systems
- extensive training program for Beckhoff system components.

Hotline: +49(0)5246/963-157

Fax: +49(0)5246/963-9157

E-mail: [support@beckhoff.com](mailto:support@beckhoff.com)

### 12.2 Beckhoff Service

The Beckhoff Service Center supports you in all matters of after-sales service:

- on-site service
- repair service
- spare parts service
- hotline service

Hotline: +49(0)5246/963-460

Fax: +49(0)5246/963-479

E-mail: [service@beckhoff.com](mailto:service@beckhoff.com)

### 12.3 Beckhoff headquarters

Beckhoff Automation GmbH & Co. KG

Hülshorstweg 20

33415 Verl

Germany

Phone: +49(0)5246/963-0

Fax: +49(0)5246/963-198

E-mail: [info@beckhoff.de](mailto:info@beckhoff.de)

Web: [www.beckhoff.de](http://www.beckhoff.de)

Further Support and Service addresses can be found on our website at <http://www.beckhoff.de>.

You will also find further documentation for Beckhoff components there.

## 13 Appendix I: Post Codes

During the boot phase, the BIOS generates a series of status messages (so-called "POST Codes"), which can be output with the help of a suitable reading device (POST Code card). The meanings of the POST Codes are explained in the document "Aptio™ 5.x Status Codes" from American Megatrends®, which is available from the website <http://www.ami.com>. In addition, the following OEM POST Codes are output:

Code	Description
87h	BIOS-API started
88h	PCA9535 started
89h	PWRCTRL firmware started

## **14 Appendix II: Resources**

### **14.1 Interrupt**

The resources used are independent of the setup setting. The listed interrupts and their use are given by the AT compatibility. If interrupts are to be available only on the ISA side, they must be reserved by the BIOS setup. Exclusivity on the PCI side is neither given nor possible.

## 14.2 PCI devices

The PCI devices listed here all exist on the board, including those that are detected and configured by the BIOS. Due to the BIOS setup settings it may be the case that various PCI devices or functions of devices are not activated. If devices are deactivated, the bus numbers of other devices may change as a result.

Bus	Dev.	Fct.	Controller / Slot
00	00	00	Host bridge ID 3E30
00	01	00	PCI-to- PCI bridge ID1901
00	01	01	PCI-to- PCI bridge ID1905
00	01	02	PCI-to- PCI bridge ID1909
00	02	00	VGA controller ID3E98
00	08	00	System device ID1911
00	12	00	Data acquisition/signal processing controller ID A379
00	14	00	XHCI USB controller ID A36D
00	14	02	RAM controller ID A36F
00	16	00	Communication device ID A360
00	16	03	Serial device ID A363
00	17	00	RAID controller ID 2822
00	1D	00	PCI-to-PCI bridge ID A330
00	1D	04	PCI-to-PCI bridge ID A334
00	1F	02	ISA bridge ID A306
00	1F	03	HD audio device ID A348
00	1F	04	SMBus controller ID A323
00	1F	05	Controller ID A324
00	1F	06	Ethernet controller ID 15BB
01	00	00	Ethernet controller (PCIE) ID 1533
02	00	00	Ethernet controller (PCIE) ID 1533
03	00	00	Ethernet controller (PCIE) ID 1533
05	00	00	Mass storage controller (PCIE) ID 50081BCD

## 14.3 SMB devices

The following table lists the reserved SM-Bus device addresses in 8-bit notation.

### **NOTE**

These address ranges may not be used by external devices even if the component assigned in the table doesn't exist on the motherboard.

<b>Address</b>	<b>Function</b>
34-35	API access to power supply unit
36-39	Reserved
5C-5D	NCT7491
60-6F	Reserved for DDR4
70-73	POST Code output
88-89	Slave address defined by BIOS
A0-A7	Reserved for DDR4
B0-B3	Power controller (access via BIOS-API)
B8-BB	Power controller (access via BIOS-API)



Beckhoff Automation GmbH & Co. KG  
Hülshorstweg 20  
33415 Verl  
Germany  
Phone: +49 5246 9630  
[info@beckhoff.com](mailto:info@beckhoff.com)  
[www.beckhoff.com](http://www.beckhoff.com)